

EN

Y1TA OY1TA603P0003

High-Performance Distance Sensor

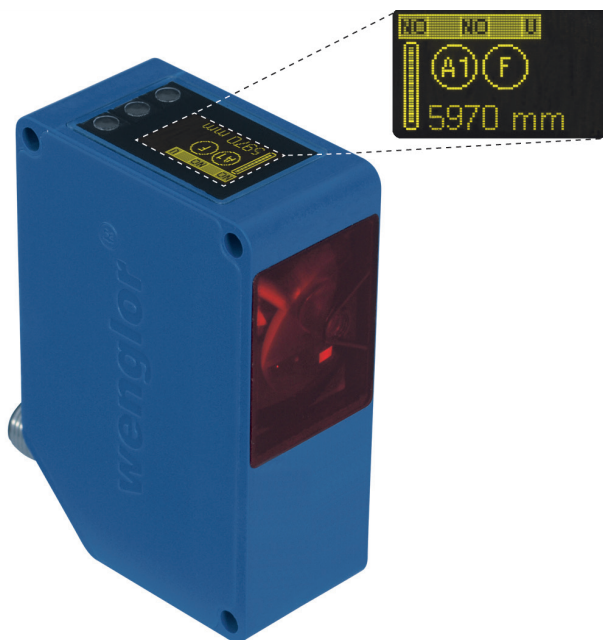

Operating Instructions

Index

1. Use for Intended Purpose	4
2. Safety Precautions	4
2.1. Safety Precautions	4
2.2. Laser/LED warning	4
2.3. Approvals and IP Protection	5
3. Device Features	6
3.1. Connecting the Sensors	8
3.2. Housing Dimensions	9
3.3. The Control Panel	10
3.4. Complementary Products	10
4. Installation Instructions	11
5. Initial Start-Up	11
5.1. Initial Start-Up	11
5.2. Default Settings	12
6. Functional Overview	13
6.1. Run	14
6.2. Pin Function	14
6.3. A1/A2/A3 Switch	14
6.4. A3 Error F/A3 Input	17
6.4.1. A3 Error	17
6.5. A1 Analog/Analog	18
6.6. Offset	20
6.7. Measuring rate	22
6.8. Laser	22
6.9. Read-Out	23
6.10. Interface	24
6.11. Display	27
6.12. Language	27
6.13. Info	27
6.14. Reset	27
6.15. Password	28

7. More Settings and Queries via the RS-232 Interface	29
7.1. Remote Control via a Terminal Program	30
7.2. Remote Control with Interface Commands	31
8. Maintenance Instructions.....	32
9. Proper Disposal	32
10. EU Declaration of Conformity	32

1. Use for Intended Purpose

This wenglor product has to be used according to the following functional principle:
High-performance distance sensors which use the principle of transit time measurement determine the distance between the sensor and the object according to the principle of transit time measurement. These sensors have a large working range and are therefore able to detect objects over large distances.
Selected sensors are distinguished by WinTec (wenglor interference free technology). This technology allows black or shiny surfaces to be reliably detected even in extremely inclined positions. It is possible to mount several sensors next to or across from each other without them influencing each other.

2. Safety Precautions

2.1. Safety Precautions

- This operating instruction is part of the product and must be kept during its entire service life.
- Read this operating instruction carefully before using the product.
- Installation, start-up and maintenance of this product has only to be carried out by trained personal.
- Tampering with or modifying the product is not permissible.
- Protect the product against contamination during start-up.
- Not a safety component in accordance with the EU Machinery Directive.

2.2. Laser/LED warning

For the respective Laser/LED Class please view the technical data of the product.



Class Laser 1 (EN 60825-1)

Observe all applicable standards and safety precautions..

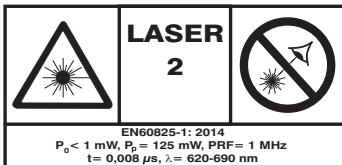

Class Laser 2 (EN 60825-1)

Observe all applicable standards and safety precautions.
The enclosed laser warning labels must be attached and visible at all time. Do not stare into beam.

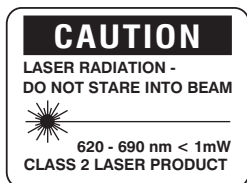

CAUTION!

Observe all applicable standards and safety precautions.
The enclosed laser warning labels must be attached and visible at all time. Do not stare into beam.

2.3. Approvals and IP Protection



RoHS

3. Device Features

Optical Data	Y1TA100 MHT88	Y1TA100 MHV80	Y1TA100 QXVT80	Y1TA100 QXT3	OY1TA603 P0003
	at object				
Working range	0,1...10,1 m	0,1...10,1 m	0,1...10,1 m	0,1...10,1 m	0,2...6,2 m
Measuring range	10 m	10 m	10 m	10 m	6 m
Linearity 0,1...5 m	0,05 %	0,05 %	0,2 %	0,5 %	0,5 %
Linearity 5...10 m	0,2 %	0,2 %	0,2 %	0,5 %	0,5 %
Switching hysteresis	3...20 mm	3...20 mm	3...20 mm	3...20 mm	3...20 mm
Light Source	Laser (red)	Laser (red)	Laser (red)	Laser (red)	Laser (red)
Wave Length	660 nm	660 nm	660 nm	660 nm	660 nm
Service life (amb. temp. = 25°C)	100000 h	100000 h	100000 h	100000 h	100000 h
Laser Protection Class (EN60825-1)	2	2	2	2	1
Beam Divergence	<2 mrad	<2 mrad	<2 mrad	<2 mrad	<2 mrad
Electrical Data					
Supply Voltage*	18...30 V DC	18...30 V DC	18...30 V DC	18...30 V DC	18...30 V DC
Current Consumption (operating voltage = 24 V)	<100 mA	<100 mA	<100 mA	<100 mA	<100 mA
Switching Frequency	50 Hz	50 Hz	50 Hz	50 Hz	50 Hz
Response Time	10...200 ms	10...200 ms	10...200 ms	10...200 ms	10...200 ms
Measuring rate	1...100/s	1...100/s	1...100/s	1...100/s	1...100/s
Temperature Drift**	<0,2 mm/k	<0,2 mm/k	<0,2 mm/k	<0,2 mm/k	<0,2 mm/k
Temperature Range	-25...60 °C	-25...60 °C	-25...60 °C	-25...60 °C	-25...60 °C
Number of switching outputs configurable as PNP NPN or push-pull	2	3	3	2	2
Switching Output Voltage Drop	<2,5 V	<2,5 V	<2,5 V	<2,5 V	<2,5 V
Switching Output Switching Current	200 mA	200 mA	200 mA	200 mA	200 mA
Error Output	yes	yes	yes	yes	yes
Error Output Switching Current	200 mA	200 mA	200 mA	200 mA	200 mA
Analog Output	0...10 V	0...10 V	0...10 V	0...10 V	0...10 V
Current Load Voltage Output	<1 mA	<1 mA	<0,5 mA	<0,5 mA	<0,5 mA
Analog Output	4...20 mA	4...20 mA	4...20 mA	4...20 mA	4...20 mA
Current Output Load Resistance	<500 Ω	<500 Ω	<500 Ω	<500 Ω	<500 Ω
Short Circuit Protection	yes	yes	yes	yes	yes
Reverse Polarity Protection	yes	yes	yes	yes	yes
Overload Protection	yes	yes	yes	yes	yes
Interface	RS-232	–	RS-232	–	–
Configuration	8 N 1	–	8 N 1	–	–
Resolution	1...12 mm	1...12 mm	1...12 mm	1...12 mm	1...12 mm
Mechanical Data					
Adjustment	Teach-In	Teach-In	Teach-In	Teach-In	Teach-In
Housing	Plastic	Plastic	Plastic	Plastic	Plastic
Protection	IP68	IP68	IP68	IP68	IP68
Connection	M12 × 1	M12 × 1	M12 × 1	M12 × 1	M12 × 1
Protection Class	III	III	III	III	III
FDA Accession Number	0710891-002				0920381-000

*Supply voltage residual ripple may not exceed 10 % (within the specified voltage range).

**Temperature Drift: 0,4 mm/k at ambient temperature < -10 °C and > 50 °C

Measuring Range:

The Sensors' measuring range is determined by object remission.

Maximum range of **Y1TA**

Up to 10 m on white (90 % remission)
 Up to 5 m on gray (18 % remission)
 Up to 3 m on black (6 % remission)

OY1TA603P0003

Up to 6 m on white (90 % remission)
 Up to 5 m on gray (18 % remission)
 Up to 3 m on black (6 % remission)

Light Spot Diameter

Working Distance	0	6 m	10 m
Light Spot Diameter Y1TA	5 mm	< 12 mm	< 20 mm

Dependence of Hysteresis and Resolution on the Measuring rate on white (90 % Remission)

Y1TA100				
Selected sampling rate in Hz	Default setting for min. hysteresis in mm	Resolution in mm		
		0,1...3 m	3...5 m	5...10,1 m
100	20	3	5	12
50	15	2	3	10
20	10	2	2	8
10	8	1	2	7
5	6	1	2	6
2	4	1	1	6
1	3	1	1	6

OY1TA603P0003				
Selected sampling rate in Hz	Default setting for min. hysteresis in mm	Resolution in mm		
		0,2...3 m	3...5 m	5...6 m
100	20	3	5	12
50	15	2	3	10
20	10	2	2	8
10	8	1	2	7
5	6	1	2	6
2	4	1	1	6
1	3	1	1	6

3.1. Connecting the Sensors

Y1TA100MHV80

514

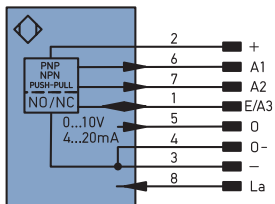

Y1TA100MHT88

516

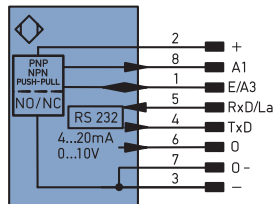

Y1TA100QXT3/OY1TA603P0003

755

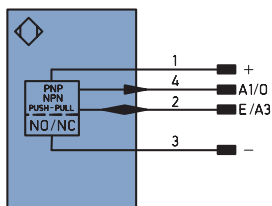

Y1TA100QXVT80

756

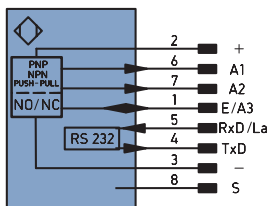

Switching laser light off via pin connection:

If the "La" pin is open or connected to negative, the laser is on.

If positive voltage is applied, the laser is off.

In the case of Y1TA100QXT3 and Y1TA100QXVT80, Pin "A1" can also be used as an analog output. The reference to ground here is Pin "-" (supply voltage "0 V").

Connecting Cables M12 × 1, 8-pin

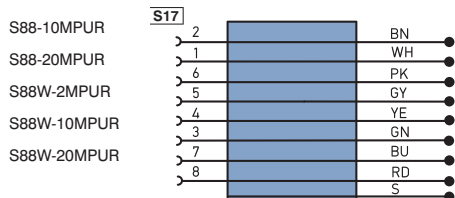

Connecting Cables M12 × 1, 8-pin

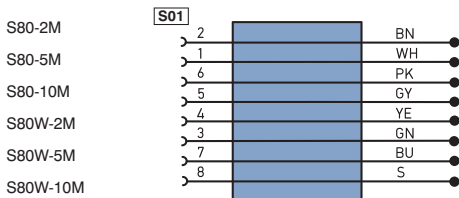

Connecting Cables M12 × 1, 4-pin

[S02]

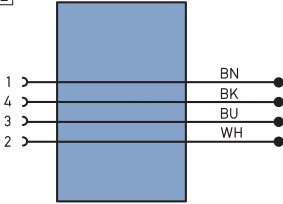

Connecting Cables M12 × 1, 4-pin

[S02]

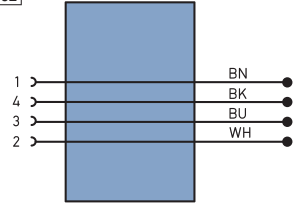

Legend

+	Supply Voltage +
-	Supply Voltage 0 V
~	Supply Voltage (AC Voltage)
A	Switching Output (NO)
Ä	Switching Output (NC)
V	Contamination/Error Output (NO)
Ÿ	Contamination/Error Output (NC)
E	Input (analog or digital)
T	Teach Input
Z	Time Delay (activation)
S	Shielding
RxD	Interface Receive Path
TxD	Interface Send Path
RDY	Ready
GND	Ground
CL	Clock
E/A	Output/Input programmable
	IO-Link
PoE	Power over Ethernet
IN	Safety Input
OSSD	Safety Output
Signal	Signal Output
BL_D+/-	Ethernet Gigabit bidirect. data line (A-D)
EN _{0/RS422}	Encoder 0-pulse 0-0 (TTL)

PT	Platinum measuring resistor
nc	not connected
U	Test Input
Ū	Test Input inverted
W	Trigger Input
W-	Ground for the Trigger Input
O	Analog Output
O-	Ground for the Analog Output
BZ	Block Discharge
AWV	Valve Output
a	Valve Control Output +
b	Valve Control Output 0 V
SY	Synchronization
SY-	Ground for the Synchronization
E+	Receiver-Line
S+	Emitter-Line
±	Grounding
SnR	Switching Distance Reduction
Rx +/-	Ethernet Receive Path
Tx +/-	Ethernet Send Path
Bus	Interfaces-Bus A(+)/B(-)
La	Emitted Light disengageable
Mag	Magnet activation
RES	Input confirmation
EDM	Contactur Monitoring

EN _{A/RS422}	Encoder A/Ä (TTL)
EN _{B/RS422}	Encoder B/B (TTL)
EN _A	Encoder A
EN _B	Encoder B
AMIN	Digital output MIN
AMAX	Digital output MAX
AOK	Digital output OK
SY _{in}	Synchronization In
SY _{OUT}	Synchronization OUT
O _L T	Brightness output
M	Maintenance
rsv	reserved
Wire Colors according to IEC 60757	
BK	Black
BN	Brown
RD	Red
OG	Orange
YE	Yellow
GN	Green
BU	Blue
VT	Violet
GY	Grey
WH	White
PK	Pink
GNYE	Green/Yellow

3.2. Housing Dimensions

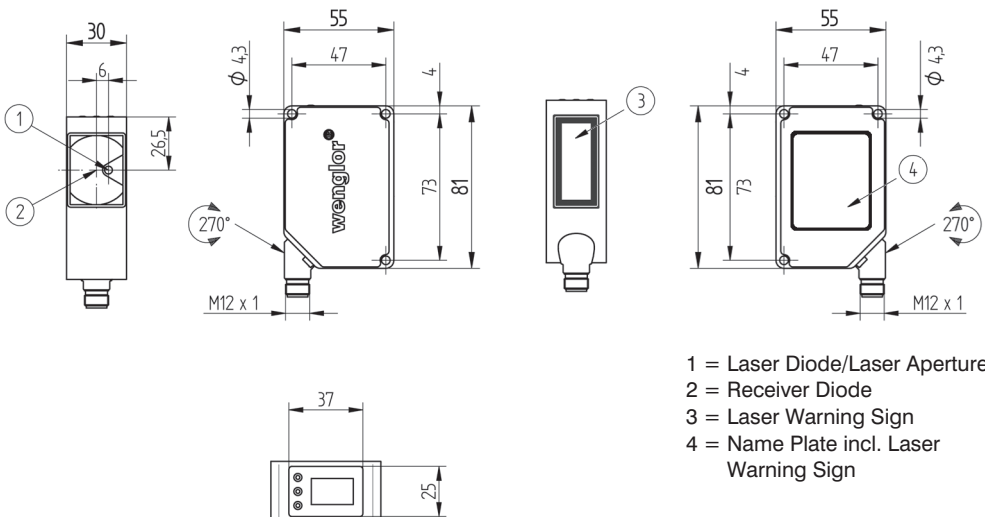

- 1 = Laser Diode/Laser Aperture
- 2 = Receiver Diode
- 3 = Laser Warning Sign
- 4 = Name Plate incl. Laser Warning Sign

3.3. The Control Panel

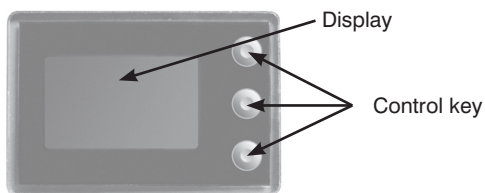

A warning triangle in the display indicates that the Sensor receives a lot of light, e.g. through a glossy surface of the object. The measurement value could be around 400 mm too low in this case. To find a remedy, see the mounting instructions in case of glossy surfaces.

3.4. Complementary Products

wenglor offers Connection Technology for field wiring.

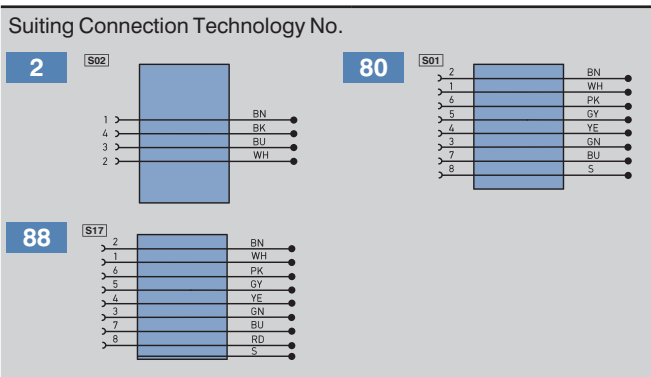

Suiting Mounting Technology No. **340**

Analog Evaluation Unit AW02

Protection Housing Set ZST-NN-02

Interface Cable S232W3

Feldbus Gateways ZAGxxxN01

4. Installation Instructions

All applicable electrical and mechanical regulations, standards and safety precautions must be adhered to when installing and operating the Sensor. The Sensor must be protected against mechanical influences. Install the device such that its installation position cannot be inadvertently changed. The wenglor mounting system is recommended for installing the Sensor. In order to obtain best possible results, the device's optics should be aligned at a right angle to the direction in which the objects are conveyed.



At brilliant surfaces, mount the Sensor in an angle of 5° to avoid a direct reflexion beam into the lens.

5. Initial Start-Up

5.1. Initial Start-Up

Connect the Sensor to supply power (18 to 30 V DC). The display view appears. The Sensor is ready for operation after 2 seconds. The following table provides an overview of typical, additional deviations during the warm-up phase.

Time (min.)	0	1	2	5	10	15
Deviation (mm)	±10	±7	±6	±2	±1	0

Switch to the configuration menu by pressing any key.

Note:

If no settings are adjusted in the configuration menu for a period of 30 s, the Sensor is automatically returned to the read-out view. The Sensor accesses the last used menu view when a key is once again activated.

If a setting is adjusted, it becomes active when the configuration menu is exited.

The keys are used for navigation, and for configuring settings.

Important:

Do not use any sharp objects to press the keys when configuring settings, because they might otherwise be damaged.

- ▲ Navigation up.
- ▼ Navigation down.
- ◀ Acknowledge the selected menu item (arrow points towards the display).
- ▶ Accept the selected setting, exit the menu (arrow points away from the display).

5.2. Default Settings

		OY1TA603P0003	Y1TA
Pin Function		A1: Switching output	A1: Switching output
			A2*: Switching output
		A3: Error output	A3: Error output
Outputs	Teach Mode	Object	Object
	Switching threshold	1000 mm	1000 mm
	Hysteresis	20 mm	20 mm
	Window Size	50 mm	50 mm
	PNP/NPN	PNP	PNP
	NO/NC	NO	NO
	ON Delay	0 ms	0 ms
	OFF Delay	0 ms	0 ms
Error output	Impulse	0 ms	0 ms
	PNP/NPN	PNP	PNP
A3 Input	NO/NC	NO	NO
	invers		
Analog	U/I	U	U
	0 V	200 mm	100 mm
	10 V	6200 mm	10100 mm
Offset	Specification Offset	0 mm	0 mm
Measure Rate		100 Hz	100 Hz
Laser		An	An
Run Mode	Display Mode	Distance	Distance
Interface**	Mode		Comm
	Baud Rate		38400
	ASCII		binary
	Interval		100 ms
	Mask		1
Display	Intensity	Screensaver	Screensaver
Language		German	German
Password	Enable	Off	Off
	Enter	0	0

* Does apply to Y1TA100MHV80 and Y1TA100QXVT80

** Does apply to Y1TA100MHT88 and Y1TA100QXVT80

6. Functional Overview

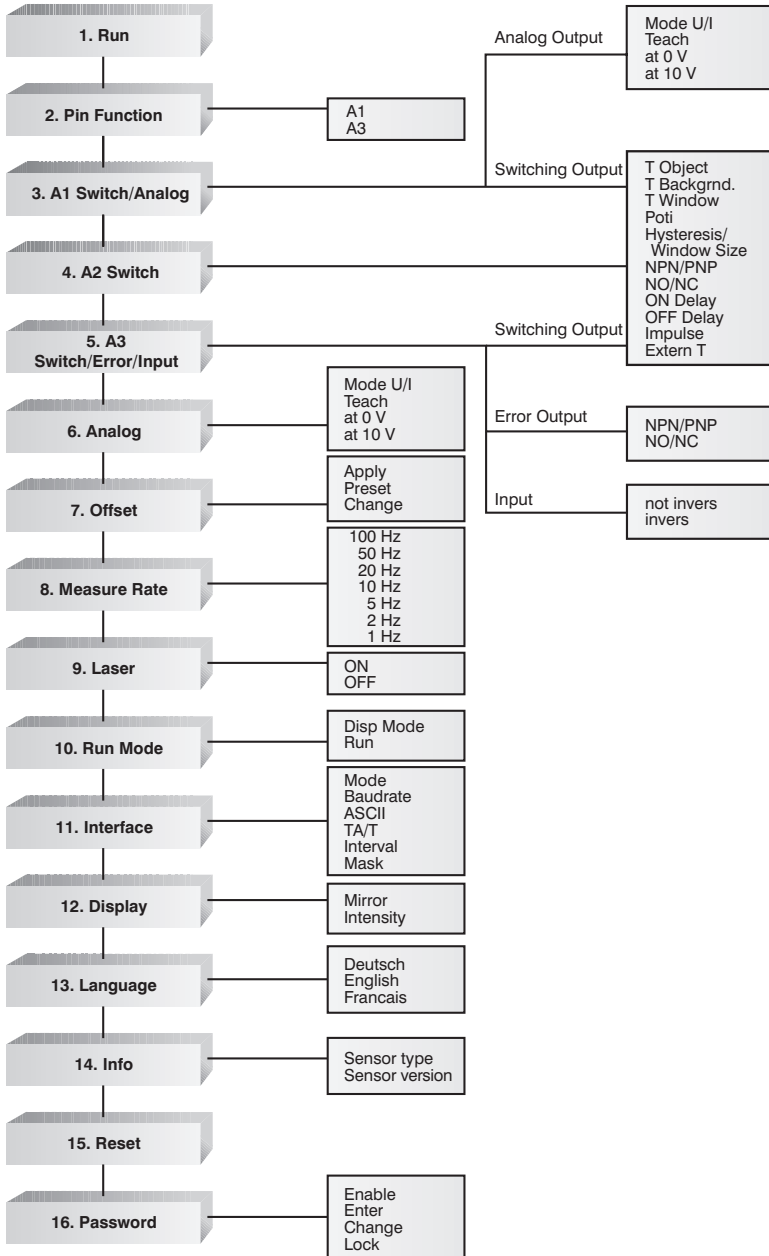



6.1. Run









The Sensor can be switched to the display mode by pressing the ◀ key.

6.2. Pin Function

The Pin Function serves to determine the function of the pins A1 or A3. The pins can each take on different functions.

Designation	Function	Key designation		
A1	Configuration of Pin A1	▲	▶	▼
	(does apply to Y1TA100QXVT80, Y1TA100QXT3 or OY1TA603P0003) By pressing the buttons ▲ and ▼ Pin A1 can be configured as a switching output or analog output.			
A3	Configuration of Pin A3	▲	▶	▼
	By pressing the button ▲ and ▼ Pin A3 can be configured as: <input type="radio"/> a switching output <input type="radio"/> an input for application of the offset <input type="radio"/> an error output <input type="radio"/> a Teach-Input for A1 <input type="radio"/> an input for switching on/off the transmitted light <input type="radio"/> a Teach-Input for A2 (if A2 available)			





The adjusted function of the pins is displayed figuratively in the menu “Run Mode”:



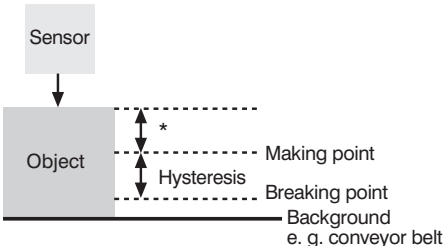

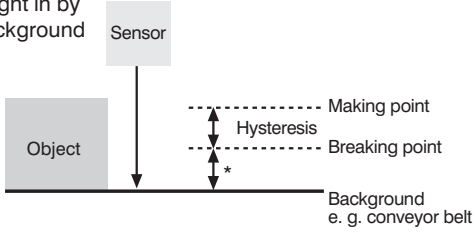

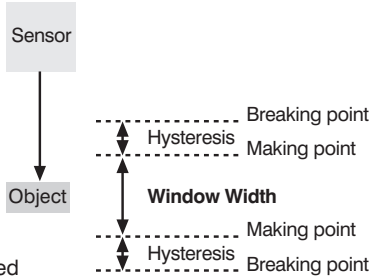
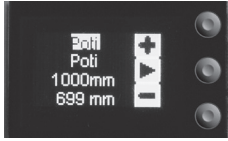
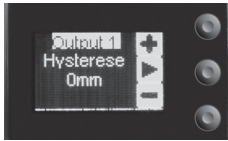

 	Teach-Input A3 for A1 or A2
  	Switch output
	Analog output
	Input
	Error output

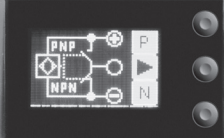

6.3. A1/A2/A3 Switch

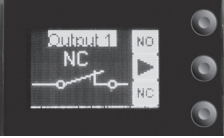
Basic settings for the individual switching outputs are selected in the A1/A2/A3 Switch menu.

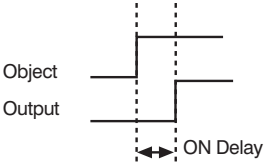
Designation	Function	Key designation		
T Object	Object Teach-In	T	▶	
	Distance to the object is taught in by pressing the T key: <ul style="list-style-type: none"> Align the spot to the object. Briefly press the T key. <ul style="list-style-type: none"> → Switching distance to the object is set. If necessary, readjust the switching distance with the help of the Potentiometer menu item. <p>* Y1TA: $\left(\frac{\text{Hysteresis}}{2}\right) + 10 \text{ mm}$</p>			
				

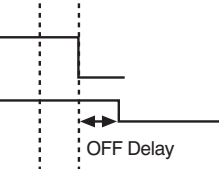
Designation	Function	Key designation		
T Backgrnd.	Background-Teach-In	T	▶	
	<p>Distance to the background is taught in by pressing the T key, so that the background can be suppressed:</p> <ul style="list-style-type: none"> Align the spot to the background (e.g. conveyor belt). Briefly press the T key. → The background is suppressed. <p>* Y1TA: $(\frac{\text{Hysteresis}}{2}) + 10 \text{ mm}$</p>			
T Window	Teach-In a tolerance window	T	▶	
	<p>A window tolerance is taught in by pressing the T key:</p> <ul style="list-style-type: none"> Align the spot to the object. Briefly press the T key. → A tolerance window is set up around the measured distance. <p>The window width value is adjustable (see below). The default value is 50 mm. If the measuring distance lies within the window width, the sensor is activated.</p> <p>When the window is taught in, the lower (L) and upper (H) switching points are displayed alternately in line 3.</p>			
Poti	Readjusting the switching distance	+	▶	-
	<p>The switching distance can be readjusted by pressing the + or the - key.</p>			
Hysteresis	Adjusting switching hysteresis	+	▶	-
	<p>The hysteresis value is adjusted by pressing the + or the - key. Minimum value: depends upon the Measuring rate (see table page 7)</p>			
Window Size	Setting the desired window width	+	▶	-
	<p>(Can only be adjusted after Teach Window). The width (10 mm...1000 mm) of the tolerance window is selected by pressing the + or the - key. The default value is 50 mm.</p>			

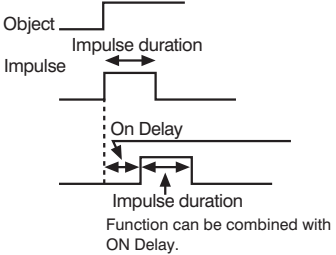
Designation	Function	Key designation		
NPN/PNP	Configuring the outputs	P	▶	N
	<p>The output is preset to PNP. Pressing the N key sets the output to push-pull. Pressing the N key again sets the output to NPN.</p> <p>The respective circuit diagram indicates how the output is set:</p> <div style="display: flex; justify-content: space-around; align-items: flex-start;"> <div style="text-align: center;"> <p>PNP</p>  </div> <div style="text-align: center;"> <p>Push-pull</p>  </div> <div style="text-align: center;"> <p>NPN</p>  </div> </div>			
NO/NC	Configuring the outputs	NO	▶	NC
	<p>Outputs can be set up as normally open or normally closed by pressing the NO or the NC key. The respective circuit diagram is displayed.</p>			
ON Delay	Adjusting ON Delay	+	▶	-
	<p>ON Delay can be set to a value within a range of 0 to 10.000 ms by pressing the + or the - key.</p>			
OFF Delay	Adjusting OFF Delay	+	▶	-
	<p>OFF Delay is adjusted by pressing the + or the - key. OFF Delay is disabled if a impulse duration has already been selected. If this is the case, Impulse! appears at the control panel.</p>			

Designation	Function	Key designation		
Impulse	Adjusting impulse duration	+	▶	-
	<p>Impulse duration defines how long the output signal remains in the activated state. Impulse duration can be set to a value within a range of 0 to 10.000 ms by pressing the + or the – key. After the selected impulse duration has elapsed, the output signal is returned to the deactivated state..</p>			
Extern T	External Teach-In	▼	◀	▶
	<p>By pressing the button ▼ can be selected, if an “Object Teach-In”, a “Background Teach-In”, or “Teach-In of a tolerance window” is executed at the External Teach-In.</p>			

6.4. A3 Error F/A3 Input

6.4.1. A3 Error

The error output is activated if no light signal is returned to the Sensor.

Designation	Function	Key designation		
NPN/PNP	Output configuration	P	▶	N

The error output is set to PNP, push-pull or NPN by pressing the **P** or the **N** key. The respective circuit diagram is displayed.

NPN/PNP	Output configuration	NO	▶	NC
---------	----------------------	----	---	----

The error output is set up as normally open or normally closed by pressing the **NO** or the **NC** key. The respective circuit diagram is displayed.

7.4.2 A3 Input

If Pin "A3" is used as input "Emitted light disengageable" or as input "Offset", the input can be set as an inverted or non-inverted input.

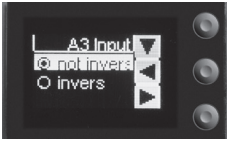
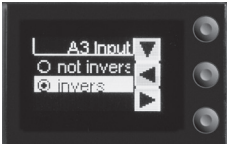
Designation	Function	Key designation		
not invers	Usage as non-inverted input	▼	◀	▶
	<p>Normally, the input is at supply voltage "0". The functionality of the input is triggered upon applying a voltage > 7 V.</p>			
invers	Usage as inverted input	▼	◀	▶
	<p>The input is normally at a voltage of > 7 V. The functionality of the input is triggered upon applying a voltage < 7 V.</p>			

6.5. A1 Analog/Analog

The measuring range for the analog output can be freely selected within the specified working range with rising or falling characteristic curve.

The adjusted measuring range must have a value of at least 2 % of the total measuring range.

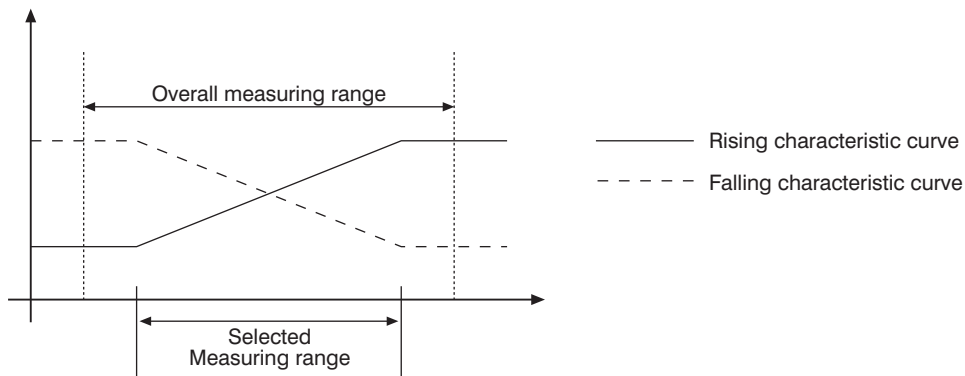

Note: The menu item is only present for the Sensors Y1TA100QXVT80, Y1TA100QXT3 and OY1TA603P0003 if pin function “Analog” is set.

Designation	Function	Key designation		
Mode U/I	Analog output as current or voltage output	U	▶	I

The analog output can be set up as either a current or a voltage output by pressing the **U** or the **I** key. The corresponding symbol is displayed.

Teach	Teach in the distances which correspond to the upper and lower voltage values	10 V respectively 20 mA	▶	0 V respectively 4 mA
-------	---	-------------------------------	---	-----------------------------

The momentary actual distance is assigned to a voltage value of **10 V** or a current value of **20 mA** by pressing the 10 V or the 20 mA key.

The momentary actual distance is assigned to a voltage value of **0 V** or a current value of **4 mA** by pressing the 0 V or the 4 mA key.

If necessary, the assigned distances can be readjusted with the help of menu items **At 0 V** or at **10 V**.

at 0 V	Distance at 0 V	+	▶	-
--------	-----------------	---	---	---

The distance assigned to either 0 V or 4 mA is adjusted by pressing the + or the - key.

at 10 V	Distance at 10 V	+	▶	-
---------	------------------	---	---	---



The distance assigned to either 10 V or 20 mA is adjusted by pressing the + or the - key.

6.6. Offset

The function Offset serves to change the current measurement value to a certain other value. Here, the switching thresholds and the analog measurement ranges are changed as well.

The offset can take place optionally via a menu or externally via Pin A3.

Via menu

Designation	Function	Key designation		
Apply*	Accepting the value set in “Specification” as the distance.	T	◀	Z
	Upon pressing the button T , the offset value set in the menu option Specification is accepted as the distance. Upon pressing the button Z , the offset function is reset and the real distance is displayed.			
Preset*	Teaching the offset value	T	◀	Z
	Upon pressing the button T , the current distance is accepted as the specification offset. Upon pressing the button Z , the offset specification value is set to 0 (the offset is activated in the menu option Apply)			
Change	Changing the offset value that has been set in steps	▲	◀	▼
	By pressing the keys + or - the adjusted specification offset (menu point Preset) can be changed stepwise upwards or downwards.			

*The currently set specification offset is displayed in line 3. The current distance is displayed in line 4.

Via Pin “A3”

Via the multifunctional pin A3, the offset equalization can be applied through an external trigger Sensor (corresponds to the menu **Offset** → **Apply** → **T**. Here, **A3** must be configured by means of the setting **Offset** as input (see chapter “7.2. Pin Function” on page 14).

In order to apply the Offset equalization, a voltage > 7 V should be applied at the input pin to trigger a positive flank. Here, the value set in the menu option **Preset** is accepted as the current distance.

Without Offset equalization:

In the diagram, the Sensor measures a distance of 5000 mm.
The switching point is located 2000 mm distant, at 7000 mm.

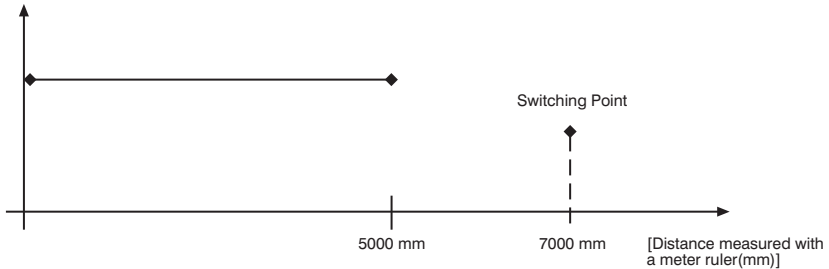

With application of the offset equalization: Specification offset: 0 mm

In the diagram, the Sensor measures a distance of 5000 mm. The switching point is located 2000 mm distant, at 7000 mm. After application of the offset equalization, from the distance 5000 mm the distance becomes 0 mm. The switching distance thus gets displaced by 7000 mm to the actual 12000 mm.

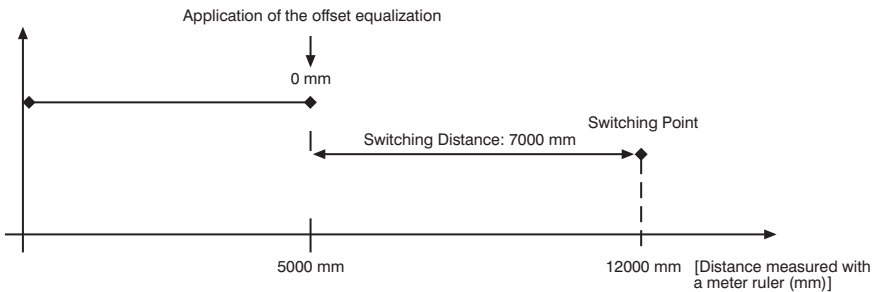

Application of the offset equalization: Specification offset: 3000 mm

In the diagram, the Sensor measures a distance of 5000 mm. The switching point is located 2000 mm distant, at 7000 mm. After application of the offset equalization, from the distance 5000 mm the distance becomes 3000 mm. The switching distance thus gets displaced by 4000 mm to the actual 9000 mm.

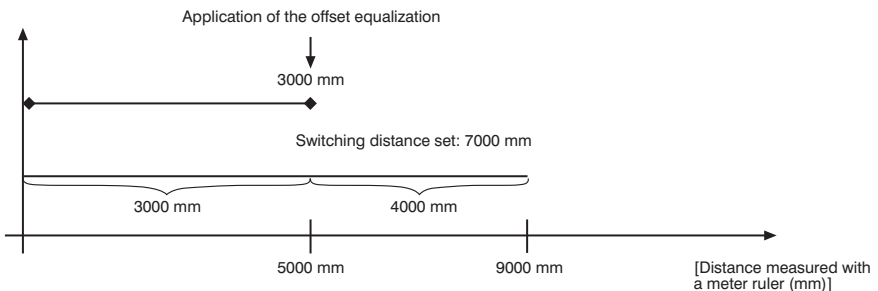

Example of application:

A Y1TA100MHV80 is used in a high rack warehouse with varying ambient temperatures. To eliminate the temperature drift, a reference path of 1000 mm is specified to the Sensor as the specification offset. Through an external trigger Sensor, the specification offset is applied and given to the Sensor as the current distance. This ensures that the distance tallies with the value of the reference route with every trigger signal and thus, the varying ambient temperature has no influence on the measurement values of the Sensor.

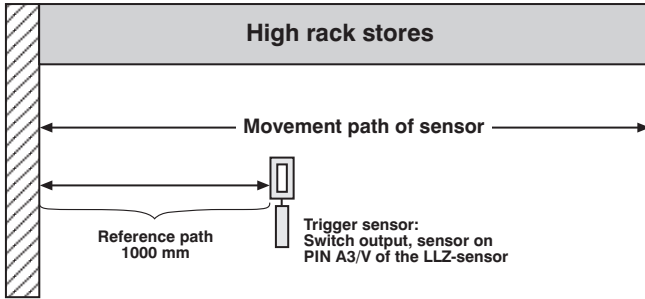

6.7. Measuring rate

Reducing the Measuring rate improves resolution and reduces minimum selectable switching hysteresis. The respective minimum and maximum values are in the table on page 7.

Designation	Function	Key designation		
100 Hz	Measuring rate value	▼	◀	▶
50 Hz				
20 Hz				
10 Hz				
5 Hz				
2 Hz				
1 Hz				

The Measuring rate which is best suited for the respective application can be selected from the predefined values by pressing the ▼ or the ◀ key.

6.8. Laser

Transmitted light can be either deactivated or activated with the help of the **Laser** menu.

Designation	Function	Key designation		
ON	Switch transmitted light on	▼	◀	▶
OFF	Switch transmitted light off			

Transmitted light is deactivated or activated by pressing the ▼ or the ◀ key.

For the products Y1TA100MHT88 and Y1TA100QXVT80 the laser light can be switched off via pin 5, by connecting pin 5 to 24 V. If Pin 5 has already been set as an RS-232 interface, the laser diode can be switched off with an interface command, in the menu or via the A3 input (see chapter „7.2. Pin Function“/„7.4.2 A3 Input“). In case of the Y1TA100MHV80 the laser diode can be switched off via pin 8, by connecting pin 8 to 24 V.

6.9. Read-Out

Which data will be read out to the display as measurement results are selected in the **Read-Out** menu.

Note: The menu item is only present for the Sensors Y1TA100QXVT80, Y1TA100QXT3 and OY1TA603P0003 if pin function "Analog" is set. The option "Analog" is only present for the sensors Y1TA100MHT88 and Y1TA100MHV80.

Designation	Function	Key designation		
DispMode	Select display characteristics	▼	◀	▶

What will appear at the monitor during display mode operation is selected by pressing the ▼ or the ◀ key:

Distance: The states of the individual outputs appear at the display.

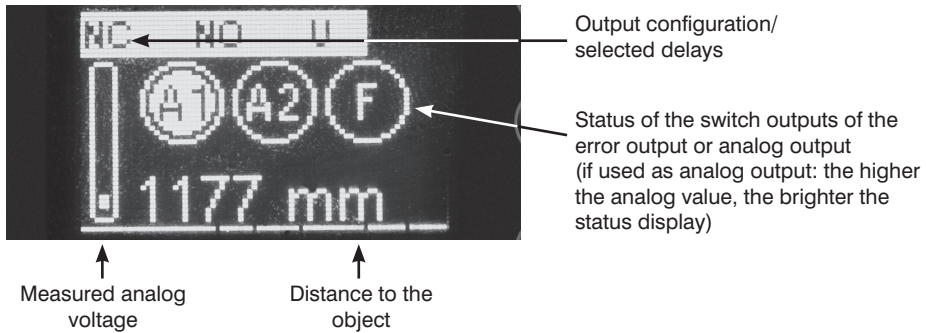

Analog: The analog output value appears at the display.

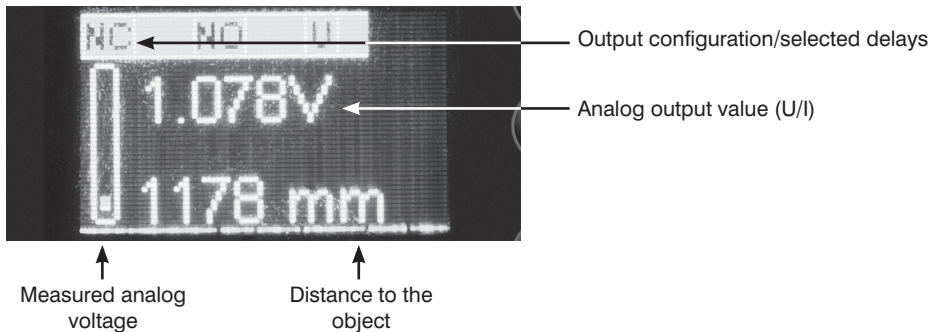

Run	Switch to the read-out view	▼	◀	▶
-----	-----------------------------	---	---	---

The device is switched to the display mode by pressing the ◀ key.

6.10. Interface

(does apply to Y1TA100QXVT80 and Y1TA100MHT88)

The basic settings for the interface are entered to the **Interface** menu.

Designation	Function	Key designation		
Mode	Basic interface settings	▼	◀	▶

One of the function types, namely **Menu**, **Comm** (default setting) or **Continuous**, is selected by pressing the ▼ and the ◀ key.

Menu: The sensor can be addressed with the help of a terminal program. A menu is generated automatically in the terminal program (see chapter 8.1).

Comm: The sensor can be addressed by means of interface commands (see chapter 8.2).

Continuous: The sensor reads out selected information at a defined interval.

Baud rate	Set the baud rate	▼	◀	▶
-----------	-------------------	---	---	---

The interface can be set to one of three baud rates by pressing the ▼ and the ◀ key:
9.600, 38.400 (default setting) or 115.200 Baud.

Continuous transmission: If continuous transmission is used, the values selected from the table shown below are transmitted via the interface at a defined interval.

ASCII	Selection of the output format for continuous transmission	▲	▶	▼
-------	--	---	---	---

Selection is made between the two output formats, ASCII or binary (default setting), by pressing the ▼ or the ◀ key.

TA/T	Selection of the interface protocol	▲	▶	▼
------	-------------------------------------	---	---	---

Switching between the old and new interface protocols (Y1TA and YT respectively) is possible by pressing the ▼ or the ◀ key.

Interval	Selection of the transmission interval for continuous transmission	+	▶	-
----------	--	---	---	---

The length of the interval specifies how frequently data will be transmitted via the interface.

The interval can be set within a range of 10 to 10.000 ms by pressing the + or the - key.

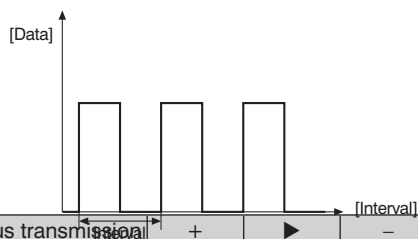

Mask	Selection of the desired output values for continuous transmission	+	▶	-
------	--	---	---	---

The selected mask specifies which information will be read out to the interface during continuous transmission. Selection can be made from masks 1 through 31 by pressing the + or - key.

The individual output values are explained in the following pages.

The individual values are read out consecutively to a single line. Only the values for the selected columns are read out.

1	2	3	4	5	6	7
Mask	Current distance +#####mm	Statuses of the digital outputs #####	Difference between current distance and the selected switching point (for each output) +#####mm+#####mm+#####mm	Digital read-out of the current or the voltage value (depending on the setting in the "Analog" menu) #####mV	Time stamp in ms #####	Transmission time in ms (packet) is displayed in line 4 of the "Mask" menu function. 9600 38400 115200
String						
1	X					11,28 2,82 0,94
2		X				4,92 1,23 0,41
3	X	X				16,2 4,05 1,35
4			X			33,84 8,46 2,82
5	X		X			45,12 11,28 3,76
6		X	X			38,76 9,69 3,23
7	X	X	X			50,04 12,51 4,17
8				X		11,28 2,82 0,94
9	X			X		22,56 5,64 1,88
10		X		X		16,2 4,05 1,35
11	X	X		X		27,48 6,87 2,29
12			X	X		45,12 11,28 3,76
13	X		X	X		56,4 14,1 4,7
14		X	X			50,04 12,51 4,17
15	X	X	X	X		61,32 15,33 5,11
16					X	10,2 2,55 0,85
17	X				X	21,48 5,37 1,79
18		X			X	15,12 3,78 1,26
19	X	X			X	26,4 6,6 2,2
20			X		X	44,04 11,01 3,67
21	X		X		X	55,32 13,83 4,61
22		X	X		X	48,96 12,24 4,08
23	X	X	X		X	60,24 15,06 5,02
24				X	X	21,48 5,37 1,79
25	X			X	X	32,76 8,19 2,73
26		X		X	X	26,4 6,6 2,2
27	X	X		X	X	37,68 9,42 3,14
28			X	X	X	55,32 13,83 4,61
29	X		X	X	X	66,6 16,65 5,55
30		X	X	X	X	60,24 15,06 5,02
31	X	X	X	X	X	71,52 17,88 5,96

Explanation of the individual output values:

Column 2: current distance: read-out of the respective current measuring distance in mm

Column 3: statuses of the digital outputs:

0: not switched

1: switched

#	#	#	#
F	A3	A2	A1

Example: 1001 → error output and output 1 switched.

Column 4: difference between current distance and the selected switching point (for each output)

Example:

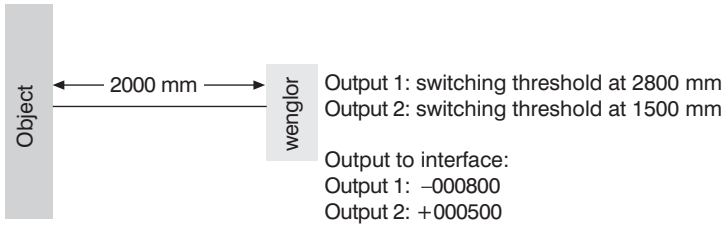

Column 5: digital read-out of the current or the voltage value in mV (depending on the setting in the “Analog” menu)

Column 6: time stamp

Example:

Time Stamp	Measuring Distance
00001024	1805 mm
00001066	1810 mm
99999999	2068 mm
00000000	2068 mm

By outputting the time-stamp, the individual measurement distances can be assigned to a relative time without taking into consideration the processing speed of the computer.

Time stamp: $\Delta 1 \cong 500 \mu\text{s}$

6.11. Display

The display can be rotated and brightness can be adjusted with the help of the **Display** menu.

Designation	Function	Key designation		
Rotated	The display is rotated 180°.	▼	◀	▶

The display is rotated 180° by pressing the ◀ key. The display can be returned to its original position by pressing the same key once again.

Intensity	Adjusting display intensity	▼	◀	▶
-----------	-----------------------------	---	---	---

After pressing the ▼ or ◀ key, the menu appears immediately with the selected intensity (min., normal or max). By selecting the energy saving mode the display switches off after one minute without activating a key. It switches on automatically, when activating a key again.

Note: If none of the keys are activated for a given period of time, the display is switched to the energy saving mode and the intensity is reduced. The display is returned to the selected intensity as soon as any key is activated.

6.12. Language

The desired menu language can be selected in the **Language** menu.

Designation	Function	Key designation		
Deutsch	Default language	▼	◀	▶
English	Menu language	▼	◀	▶
Francais	Menu language	▼	◀	▶

The desired language is selected by pressing the ▼ or ◀ key. The desired language appears in the menus as soon as it has been selected.

6.13. Info

The following information regarding the Sensor is displayed in the **Info** menu:

- Sensor type
- Software version
- Serial number

6.14. Reset







Sensor settings can be returned to their default values with the help of the **Reset** menu. Default settings are listed in section "Default settings".

Designation	Function	Key designation		
Reset	Press <R> to reset	R	◀	

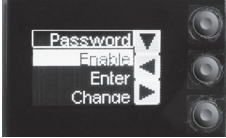
All of the selected sensor settings are returned to their default values by pressing the **R** key.

6.15. Password

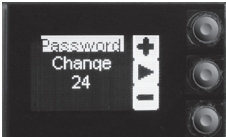
Password settings can be entered in the password menu with the following four submenus.

Designation	Function	Key designation		
Enable	Switch Password Function On or Off	▼	◀	▶
	<p>The Enable menu is accessed by pressing the ◀ key, where you can activate or deactivate the password function by selecting Off or On. After interruption of the power supply, the operation of the sensor is locked. Immediate blockage of the operation can be done in the sub-menu "Lock".</p>			
Enter	Password Entry for Enabling the Sensor	▼	◀	▶
	<p>The Enter submenu is accessed by pressing the ◀ key, where you can enter the password in order to enable the sensor.</p>			
	<p>The desired password is entered by means of the + or – key. Press and hold the + or – key in order to scroll quickly through the numbers. Entry is acknowledged by pressing the ▶ key. The password is set to 0 upon shipment from the factory.</p>			
Change	Change the Password	▼	◀	▶
	<p>The Change submenu is accessed by pressing the ◀ key, where you can change the password.</p>			
	<p>The desired password is selected with the + or – key, and is acknowledged with the ▶ key. Press and hold the + or – key in order to scroll quickly through the numbers.</p>			
Lock	Lock after Sensor	▼	◀	▶
	<p>The sensor can be disabled with the help of this function, without interrupting supply power. The sensor is disabled and switched automatically to the password entry mode after pressing the ◀ key.</p>			
	<p>A password must be entered in order to continue using the sensor.</p>			

Notes regarding password functions:

If the password function has been activated, the password must be entered each time supply power to the Sensor is interrupted.

After pressing a key, the menu is automatically switched to the password entry mode.

The following user interface then appears:



After entering the correct password with the + or – key, the entire menu is enabled and the Sensor is ready for use.

- The password function is deactivated upon shipment from the factory.
- Passwords can be selected within a range of 0000 to 9999.

Be sure to make a note of the new password before exiting the “change password” function! If the password is forgotten, it must be overwritten with a master password. The master password can be requested by e-mail from support@wenglor.com.

7. More Settings and Queries via the RS-232 Interface

(does apply to Y1TA100QXVT80 and Y1TA100MHT88)

The interface makes use of the software handshake procedure. All settings can be configured at a PC and uploaded to the device. RS-232 interface connections RxD (5) and TxD (4) are linked to minus (pin 3, green), and can be connected to the corresponding terminals at the communication partner.

Interface configuration:

Adjustable baud rate, 8 data bits, no parity, 1 stop bit

Plug connectors included with the wenglor S232W3 plug adapter:

- 8-pin M12 plug connector for connecting the power supply and the outputs
- 8-pin M12 socket connector for direct Sensor connection
- 9-pin M12 subminiature socket connector for direct connection to the RS-232 interface at the PC, or the utilized controller

Connect the Sensor to the PC, the controller etc. via the wenglor S232W3 plug adapter. Install the plug adapter as follows:

- Disconnect the 8-conductor connector cable (S80-xx) from the Sensor.
- Connect the S232W3 plug adapter directly to the Sensor.
- Connect the 8-conductor connector cable (S80-xx) to the plug adapter.
- Connect the 9-pin subminiature socket connector at the PC to the serial interface.
- Switch the power supply on.

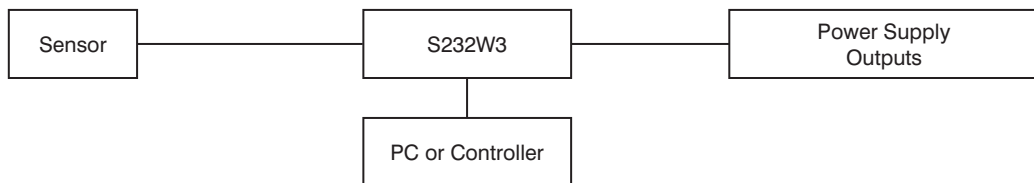

7.1. Remote Control via a Terminal Program

1. Connect the Sensor as described in chapter 8 above.

2. Set the Sensor to the Interface menu mode.

- Select the "Interface" menu item.
- Select "Mode".
- Select "Menu".

Alternatively: Select <Comm> and with F1, select remote control via Terminal-Program.

The remote control via Terminal-Program can be ended with F4.

3. Start the terminal program at the PC,

for example start the Windows® HyperTerminal® by clicking

→ Start → Programs → Accessories → Communication → HyperTerminal.

- Settings: 38.400 baud, 8, N, 1
- Select the utilized port (e.g. COM 1).
- Establish a connection.

The menu appears in the terminal program.

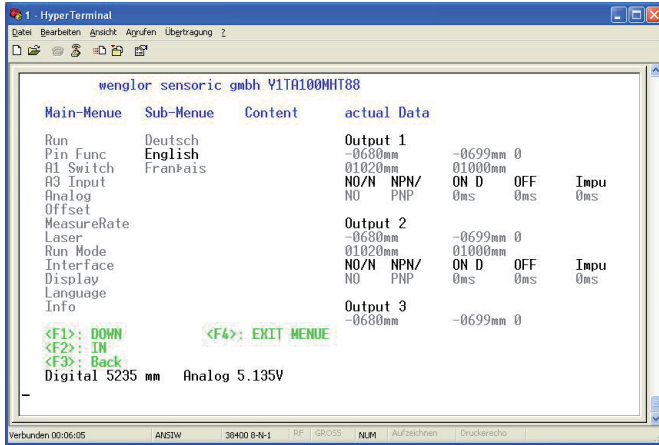

You can now navigate within the menu using the F1, F2 and F3 keys on your keyboard.

7.2. Remote Control with Interface Commands

1. Connect the Sensor as described in chapter 8 above.
2. Set the Sensor to the interface operating mode.
 - Select <Interface> from the menu.
 - Select <Mode>.
 - Select <Comm>.

The Sensor is now ready for interface communication.

The interface protocol for the Y1TA can be downloaded as a PDF document from our website at www.wenglor.com under the “download” heading.

8. Maintenance Instructions

- This wenglor Sensor is maintenance-free.
- It is advisable to clean the lens and the display, and to check the plug connections at regular intervals.
- Do not clean with solvents or cleansers which could damage the device.

9. Proper Disposal

wenglor sensoric gmbh does not accept the return of unusable or irreparable products. Respectively valid national waste disposal regulations apply to product disposal.

10. EU Declaration of Conformity

The EU declaration of conformity can be found on our website at www.wenglor.com in download area.