

CP08MHT80 OCP801H0180**CP24MHT80 OCP162H0180****CP35MHT80 OCP352H0180****High-Performance Distance Sensor**

Operating Instructions

Index

1. Proper Use	3
2. Safety Precautions	3
2.1. Safety Precautions	3
2.2. Laser/LED warning	3
2.3. Approvals and IP Protection	4
3. Technical Data	5
3.1. Complementary Products (see catalog)	7
3.2. Connection Diagram	7
3.3. Housing Dimensions	7
3.4. Control Panel	8
4. Installation Instructions	8
5. Initial Operation	8
6. Function	8
7. Adjustment	9
7.1. Manual Adjustments	9
7.2. Special Settings	12
7.3. Settings and Queries via the RS-232 interface	13
8. Maintenance Instructions	19
9. Proper Disposal	19
10. EU Declaration of Conformity	19

1. Proper Use

High performance distance sensors which use the principle of angle measurement determine the distance between the sensor and the object. These sensors have small working ranges (under 1 m) and recognize objects with high precision. Some sensors use a high-resolution CMOS line array and DSP signal processing. The color, shape and texture of the objects to be recognized does not affect the sensors' measurements. Even dark objects can be reliably detected against a bright background. They can be operated with very high speeds or very high resolutions. The measured value can be output as an analog value or via the interfaces. Furthermore, Teach-In, filter functions for adjusting a switching output, and an error output are available. The measuring range can be selected individually within the working range.

2. Safety Precautions

2.1. Safety Precautions

- This operating instruction is part of the product and must be kept during its entire service life.
- Read this operating instruction carefully before using the product.
- Installation, start-up and maintenance of this product has only to be carried out by trained personnel.
- Tampering with or modifying the product is not permissible.
- Protect the product against contamination during start-up.
- Not a safety component in accordance with the EU Machinery Directive.

2.2. Laser/LED warning



Class Laser 1 (EN 60825-1)

Observe all applicable standards and safety precautions.

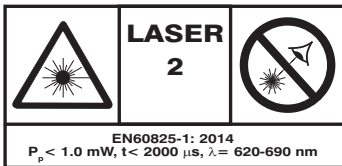

Class Laser 2 (EN 60825-1)

Observe all applicable standards and safety precautions. The enclosed laser warning labels must be attached and visible at all time. Do not stare into beam.

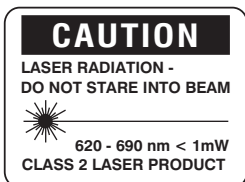

CAUTION!

Observe all applicable standards and safety precautions. The enclosed laser warning labels must be attached and visible at all time. Do not stare into beam.

2.3. Approvals and IP Protection



RoHS

3. Technical Data

	CP08MHT80	CP24MHT80	CP35MHT80
Optical Data			
Working Range	30...80 mm	40...160 mm	50...350 mm
Measuring Range	50 mm	120 mm	300 mm
Resolution	< 8 μm	< 20 μm	< 50 μm
Resolution (Speed-Mode)	< 12 μm	< 30 μm	< 80 μm
Linearity	0,1 %	0,1 %	0,15 %
Linearity (Speed-Mode)	0,2 %	0,2 %	0,2 %
Light Source	Laser (red)	Laser (red)	Laser (red)
Wave Length	660 nm	660 nm	660 nm
Laser Class	2	2	2
Service Life (25 °C)	100000 h	100000 h	100000 h
max. Ambient Light	10000 Lux	10000 Lux	10000 Lux
Electrical Data			
Supply Voltage	18...30 V DC	18...30 V DC	18...30 V DC
Light Spot Size at begin working range	0,5×1 mm	0,5×1,2 mm	0,6×1,5 mm
Light Spot Size at end working range	1×2 mm	1×2,5 mm	1,5×4 mm
Current Consumption (U _b = 24 V)	< 80 mA	< 80 mA	< 80 mA
Measuring rate	1500/s	1500/s	800/s
Response Time	660 μs	660 μs	1250 μs
Response Time (Resolution-Mode)	1660 μs	1660 μs	2500 μs
Temperature Drift	< 5 $\mu\text{m}/^{\circ}\text{C}$	< 10 $\mu\text{m}/^{\circ}\text{C}$	< 25 $\mu\text{m}/^{\circ}\text{C}$
Temperature Range	-25...50 °C	-25...50 °C	-25...50 °C
Analog Output	0...10 V	0...10 V	0...10 V
Current Output Load Resistance	< 1 mA	< 1 mA	< 1 mA
Analog Output	4...20 mA	4...20 mA	4...20 mA
Current Output Load Resistance	< 500 Ohm	< 500 Ohm	< 500 Ohm
Voltagedrop PNP-Error Output	< 2,5 V	< 2,5 V	< 2,5 V
Switching Current PNP-Error Output	< 200 mA	< 200 mA	< 200 mA
Short-Circuit Protection	yes	yes	yes
Reverse Polarity Protection	yes	yes	yes
Interface	RS-232	RS-232	RS-232
Baud Rate	38400 Bd	38400 Bd	38400 Bd
Protocol	8 N 1	8 N 1	8 N 1
Mechanical Data			
Adjustment	Teach-In	Teach-In	Teach-In
Housing	Plastic	Plastic	Plastic
Protection Mode	IP67	IP67	IP67
Connection	M12×1	M12×1	M12×1
Protection Class	III	III	III
FDA Accession Number	0820588-000	0820589-000	0820590-000

Reference material: Kodak white 90 % remission

	OCP801H0180	OCP162H0180	OCP352H0180
Optical Data			
Working Range	30...80 mm	40...160 mm	50...350 mm
Measuring Range	50 mm	120 mm	300 mm
Resolution	< 8 μm	< 20 μm	< 50 μm
Resolution (Speed-Mode)	< 12 μm	< 30 μm	< 80 μm
Linearity	0,1 %	0,1 %	0,15 %
Linearity (Speed-Mode)	0,2 %	0,2 %	0,2 %
Light Source	Laser (red)	Laser (red)	Laser (red)
Wave Length	660 nm	660 nm	660 nm
Laser Class	1	1	1
Service Life (25 °C)	100000 h	100000 h	100000 h
max. Ambient Light	10000 Lux	10000 Lux	10000 Lux
Electrical Data			
Supply Voltage	18...30 V DC	18...30 V DC	18...30 V DC
Light Spot Size at begin working range	0,5×1 mm	0,5×1,2 mm	0,6×1,5 mm
Light Spot Size at end working range	1×2 mm	1×2,5 mm	1,5×4 mm
Current Consumption (U _b = 24 V)	< 80 mA	< 80 mA	< 80 mA
Measuring rate	1000/s	1000/s	500/s
Response Time	1000 μs	1000 μs	2000 μs
Response Time (Resolution-Mode)	2000 μs	2000 μs	4000 μs
Temperature Drift	< 5 $\mu\text{m}/^{\circ}\text{C}$	< 10 $\mu\text{m}/^{\circ}\text{C}$	< 25 $\mu\text{m}/^{\circ}\text{C}$
Temperature Range	-25...50 °C	-25...50 °C	-25...50 °C
Analog Output	0...10 V	0...10 V	0...10 V
Current Output Load Resistance	< 1 mA	< 1 mA	< 1 mA
Analog Output	4...20 mA	4...20 mA	4...20 mA
Current Output Load Resistance	< 500 Ohm	< 500 Ohm	< 500 Ohm
Voltagedrop PNP-Error Output	< 2,5 V	< 2,5 V	< 2,5 V
Switching Current PNP-Error Output	< 200 mA	< 200 mA	< 200 mA
Short-Circuit Protection	yes	yes	yes
Reverse Polarity Protection	yes	yes	yes
Interface	RS-232	RS-232	RS-232
Baud Rate	38400 Bd	38400 Bd	38400 Bd
Protocol	8 N 1	8 N 1	8 N 1
Mechanical Data			
Adjustment	Teach-In	Teach-In	Teach-In
Housing	Plastic	Plastic	Plastic
Protection Mode	IP67	IP67	IP67
Connection	M12×1	M12×1	M12×1
Protection Class	III	III	III
FDA Accession Number	1120734-000	1120717-000	1120723-000

Reference material: Kodak white 90 % remission

3.1. Complementary Products (see catalog)

wenglor offers Connection Technology for field wiring.

80

Suiting Connection Technology No.

- Suiting Mounting Technology No. **380**
- Analogue Evaluation Unit AW02
 - Feldbus Gateways ZAGxxxN01
 - Interface Cable S232W3
 - Protection Housing Set ZSP-NN-02
 - Protection Housing ZSV-0x-01

3.2. Connection Diagram

529

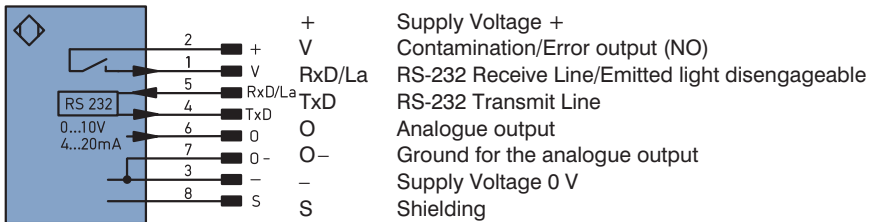

3.3. Housing Dimensions

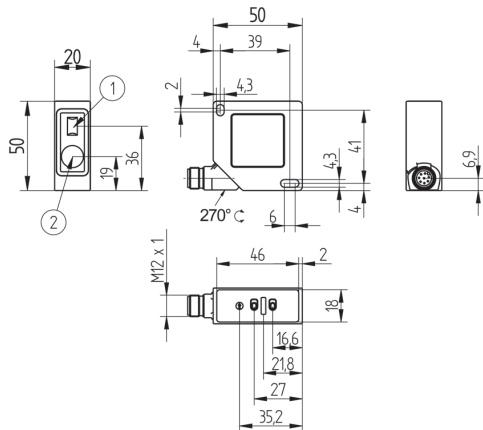

- ① = Transmitter Diode
- ② = Receiver Diode
- Screw M4 = 0,5 Nm

3.4. Control Panel

On the control panel you find the Plus key and the Minus key, several LEDs and the rotary selector switch. The rotary selector switch is used for choosing the setting- and operation functions.

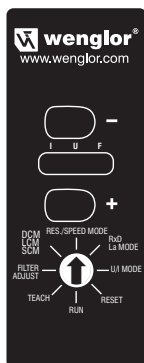

- ⊖ = Minus key (with LED)
- ⊕ = Plus key (with LED)
- I-LED (yellow) = Current output
- U-LED (yellow) = Voltage Output. Brightness is proportional to the output voltage
- F-LED (rot) = Error Output
- ⌚ = Rotary selector switch
- RUN = Sensor operation
- TEACH = Teach measurement range
- FILTER ADJUST = Filter adjustment
- DCM/SCM/LCM = Switching Default Capture Mode/Short Capture Mode/Long Capture Mode
- RES./SPEED-MODE = Switch Resolution/Speed
- RxD/La Mode = Switching RS-232 Interface/Emitted Light can be switched off
- U/I Mode = Switching 0...10 V/4...20 mA
- RESET = Reset

4. Installation Instructions

During use of the sensors, applicable electrical and mechanical regulations, standards and safety precautions must be adhered to. The sensor has to be protected against mechanical influences.

In case of very glossy surfaces the sensor has to be mounted slightly inclined and has to be mounted on a plane surface (approx. 5°), to inhibit a direct reflection of the laser beam into the optics.

5. Initial Operation

Please control the proper connection of all conductors.

Impress a supply voltage of 18...30 V DC with ripple of < 10 % (within the indicated voltage range).

The settings can be operated either with the RS-232 interface or manually.

6. Function

The sensor uses a high-resolution CMOS line array and DSP technology, virtually eliminating material, color and brightness related measurement value differences. Alternatively high speed (Speed-Mode) or high resolution (Resolution-Mode) are adjustable. Integrated analogue output can be configured for voltage 0...10 V or current 4...20 mA, error output and RS-232 interface, Teach-In, Error Output and filter functions.

Outputs

Analogue Output

The analogue output is connected to analogue earth. The analogue output can be configured as a current output or a voltage output. If you have the choice we recommend the use of the voltage output (reduced current consumption).

The analogue output reads out a standard signal of 0...10 V when configured as a voltage output (see settings). The analogue output reads out a standard signal of 4...20 mA when configured as a current output (see settings).

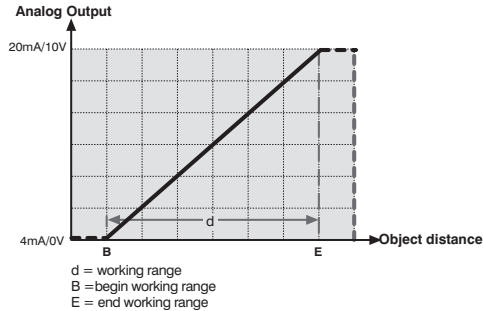

Error Outputs

The PNP error output is switched to positive if no object is detected within the selected working range, or if an error has occurred (e.g. an interrupted conductor at the current output). The red F LED lights up to indicate that the error output has been activated.





RS-232 interface

This sensor is equipped with an RS-232 interface for communication with a device such as PC or a controller. Sensor functions can be activated, and scanning results can be acquired via the RS-232 interface.

7. Adjustment

7.1. Manual Adjustments

Reset:

- Set the rotary selector switch  to **RESET**
- Briefly press the minus-key  or the plus-key 
 - red F-LED lights up
 - Delivery status restored (RES. MODE, rising characteristic function, full measuring range, filter function off.) The adjusted transmission speed (Baud rate) and the setting Current or Voltage Output is not changed by the **RESET**.
- Set the rotary selector switch  to **RUN**

Set Input

The Input can be used as RS-232 Receive Line (RxD), Emitted Light can be switched off at 24 V (La) or Emitted Light can be switched off at 0 V (Lā) .

- Rotary Selector Switch **↻** to **RxD/La Mode**

→ The **U-LED** and **I-LED** indicate the current configuration. **RxD** is preset in the delivery status. By pressing the Plus or the Minus key, the configuration can be changed.

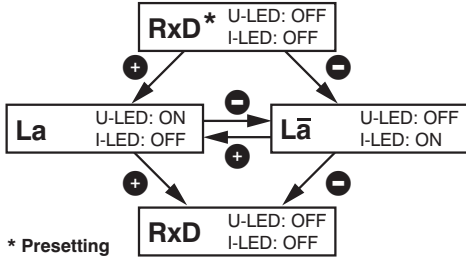

⊖ = Minus Button/LED

⊕ = Plus Button/LED

RxD = RS-232 Receive Line

La = Emitted Light can be switched off at 24 V

Lā = Emitted Light can be switched off at 0 V

* Presetting

- Set the rotary selector switch **↻** to **RUN**

Adjustment of the Output

Configuring the analogue output as a voltage output:

- Set the rotary selector switch **↻** to **U/I MODE**

→ The red **F-LED** lights up

→ If the yellow **U-LED** lights up: Analogue output presently set to 0...10 V

→ If the yellow **I-LED** lights up: Analogue output presently set to 4...20 mA

- Briefly press the plus-key **⊕**

→ The Yellow **U-LED** lights up: Analogue output reconfigured to 0...10 V (voltage output)

- Set the rotary selector switch **↻** to **RUN**

Configuring the analogue output as a current output:

- Set the rotary selector switch **↻** to **U/I MODE**

→ The red **F-LED** lights up

→ If the yellow **U-LED** lights up: Analogue output presently set to 0...10 V

→ If the yellow **I-LED** lights up: Analogue output presently set to 4...20 mA

- Briefly press the minus-key **⊖**

→ The yellow **I-LED** lights up: Analogue output reconfigured to 4...20 mA (current output)

- Set the rotary selector switch **↻** to **RUN**

Operate the sensor with high resolution (Resolution-Mode)

- Set the rotary selector switch **↻** to **RES./SPEED-MODE**

→ The red **F-LED** lights up

→ The yellow **U-LED** lights up: Sensor presently set to high speed



→ The yellow **I-LED** lights up: Sensor presently set to high Resolution

- Briefly press the minus-key **⊖**

The yellow **I-LED** lights up: Sensor now operates with high resolution.

- Set the rotary selector switch **↻** to **RUN**



Operate the sensor with high speed (Speed-Mode)

- Set the rotary selector switch  to **RES./SPEED-MODE**
 - The red F-LED lights up
 - The yellow U-LED lights up: Sensor presently set to high speed
 - The yellow I-LED lights up: Sensor presently set to high Resolution
- Briefly press the plus-key 
The yellow U-LED lights up: Sensor now operates with high speed.
- Set the rotary selector switch  to **RUN**





Adjustment of Measuring Range

You can either adjust the zero point (begin of working range) of the rising characteristic function (vide point A) or you can set the Measuring Range individually by means of the zoom function (vide points B and C). The zoom function is possible for rising and falling characteristic functions. You can restore the the full Measuring Range with Reset.





A) Adjust zero point of the Measuring Range:

- Set the rotary selector switch  to **TEACH**
- Press and hold the minus-key  until the yellow LEDs blink
 - yellow LEDs blink
 - Characteristic curve is now rising with slope over the full measuring range and the selected zero point
- Set the rotary selector switch  to **RUN**

B) Setting the measuring range for a rising characteristic function (Zoom function):

- Set the rotary selector switch  to **TEACH**
 - red F-LED lights up
- Place the object at the most distant point of the desired working range
- Briefly press the plus-key 
 - yellow I-LED lights up
- Place the object at the nearest point of the desired working range
- Briefly press the minus-key 
 - yellow LEDs light up: The two points have now been taught in
 - yellow LEDs do not light up: Teach-In must be repeated because the two points are too close to each other, or they are outside of the measuring range
- Set the rotary selector switch  to **RUN**

C) Setting the measuring range for a falling characteristic function (Zoom function):

- Set the rotary selector switch  to **TEACH**
 - red F-LED lights up
- Place the object at the most distant point of the desired working range
- Briefly press the minus-key 
 - yellow U-LED lights up
- Place the object at the nearest point of the desired working range
- Briefly press the plus-key 
 - yellow LEDs light up: The two points have now been taught in
 - yellow LEDs do not light up: Teach-In must be repeated because the two points are too close to each other, or they are outside of the measuring range
- Set the rotary selector switch  to **RUN**

7.2. Special Settings

Adjusting the filter function:

- Set the rotary selector switch \odot to **FILTER ADJUST**
 - The red **F-LED** lights up
 - The yellow **LEDs** are off: Filter function is presently disabled
 - Yellow **LEDs** blink once followed by a pause: filter currently set to level 1 (1/4 cut-off frequency)
 - Yellow **LEDs** blink twice followed by a pause: filter currently set to level 2 (1/16 cut-off frequency)
 - Yellow **LEDs** blink three times followed by a pause: filter currently set to level 3 (1/64 cut-off frequency)
- Briefly press the minus-key \ominus 1 to 3 times
 - The filter level is reduced by one each time the key is pressed
 - The blinking pattern of the yellow LEDs indicates the newly selected filter level
- Briefly press the plus-key \oplus 1 to 3 times
 - The filter level is increased by one each time the key is pressed
 - The blinking pattern of the yellow LEDs indicates the newly selected filter level
- Set the rotary selector switch \odot to **RUN**

Via the interface other filter levels are adjustable.

Optimize the exposure time

The exposure time is adapted automatically by the sensor. In the presetted DCM (Default Capture Mode) the Sensor has a fixed maximal possible Exposure Time. It can be adjusted manually in addition in case of difficult applications.

By means of the LCM (Long Capture Mode) the Exposure Time of the sensor can be elongated for dark or highly glossy objects (e.g. black lack) in order to achieve a more exact measurement.

By means of the SCM (Short Capture Mode) the Exposure Time of the sensor can be reduced for dark or highly glossy objects (e.g. black lack) in order to achieve a reduction of the drop down of the Measurement Rate.

The shining of the **U-LED** and the **I-LED** the current setting is indicated. DCM is preset in delivery status. By pressing of the Plus respectively Minus key the current setting can be changed.

- Set the rotary selector switch \odot to **DCM/LCM/SCM**

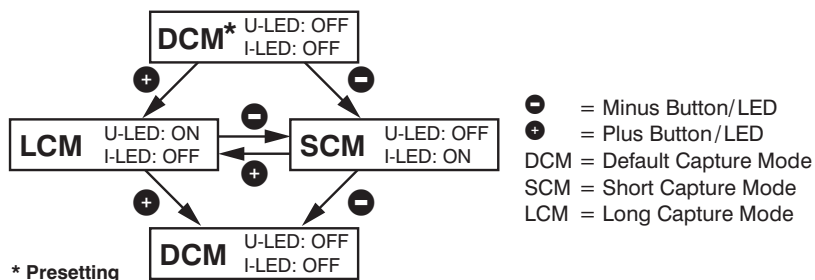

- Set the rotary selector switch \odot to **RUN**

7.3. Settings and Queries via the RS-232 interface

The interface utilises a software handshake procedure (see protocol specification below). All sensor settings can be selected digitally with a PC, and all values generated by the sensor can be read out at a PC. The RS-232 interface connections RxD (connection 5, grey) and TxD (connection 4, yellow) correspond to minus (connection 3, green) and can be connected to the appropriate connections of the communication partner.

Software Tools:

Software for the interface of the CP08 is available. Download address: www.wenglor.com

Interface configuration:

Baud rate: 38.400 baud, 8 data bits, no parity, 1 stop bit

Plug connectors of the wenglor® Plug Adapter S232W3:

- 8-pin M12 plug connector for connecting the power supply and the outputs
- 8-pin M12 socket connector for direct sensor connection
- 9-pin M12 sub-miniature socket connector for direct connection to the RS-232 interface at the PC, or the utilised controller

1) Connect the sensor over the wenglor® Plug Adapter S232W3 with PC, controller etc.

Installing the wenglor® Plug Adapter S232W3:

- Set the rotary selector switch  to **RUN**
- Disconnect the 8-conductor connector cable (S80-xx) from the sensor
- Connect the S232W3 plug adapter directly to the sensor
- Connect the 8-conductor connector cable (S80-xx) to the plug adapter
- Connect the 9-pin sub-miniature socket connector to the serial interface at the PC
- Switch the power supply on

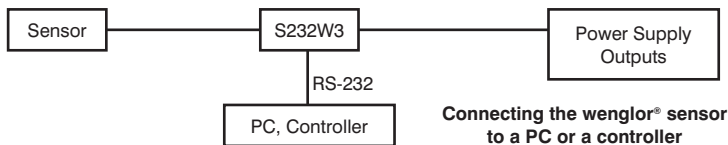

2) Procedure of the interface operation:

- Set the rotary selector switch  to **RUN**
- To enter or query the sensor settings use the interface commands according to the protocol. Every interface command and every answer of the sensor starts with "/" (ASCII 47) and ends with "." (ASCII 46) In case of an incorrect communication, the sensor emits a Negative Acknowledge character (ASCII 21). If a command is not closed with ".", the sensor remains in wait state and does not give an answer or error message.
- Even with continuous query it should be adhered to a pause of 10 ms between two interface commands.
- Because of the protocol a maximum of 100 measurement values per second can be emitted. In the case of faster applications use the analog output.

Protocol for Communications via the RS-232 Interface

Frame Layout for Data Transmission

Transmitting Partner	Characters (ASCII)		Receiving Partner	Frame Segment
Start character	/ (ASCII 47)	=>	Connect	Frame header
Length information	2 Byte	=>	Connect	Frame header
Command bytes	2 Byte	=>		Frame header
1 st data byte	2 Byte	=>	Data information	User data
2 nd data byte	2 Byte	=>		User data
..	..	=>	Data information	User data
n th Data byte	..	=>	Data information	User data
Checksum (BCC)	2 Byte	=>		Frame end
Stop bit	. (ASCII 46)	=>	Disconnected	Frame end

Calculating the Checksum BCC (Block Check Character)
 The Checksum is generated from an EXOR frame operation.

Start Character	Length	Command	Data	Checksum	Stop character
/	02	0D	00	59	.
2FH	30H 32H	30H 44H	30H 30H	35H 39H	2EH

Data used to calculate the checksum

Calculating Example:

/	2FH	=	0010	1111
0	30H	=	0011	0000
	XOR	=	0001	1111
2	32H	=	0011	0010
	XOR	=	0010	1101
0	30H	=	0011	0000
	XOR	=	0001	1101
D	44H	=	0100	0100
	XOR	=	0101	1001
0	30H	=	0011	0000
	XOR	=	0111	1001
0	30H	=	0011	0000
	XOR	=	0101	1001

Program Example:

Start
Transmitting Frame = "/020D0059." (Example) Transmitting Frame Length=10 (in this example);
checksum = 0; n = 1;
as long as: n < (Transmitting Frame Length - 3)
Checksum = Checksum EXOR Transmitting Frame charakter (n)
n = n + 1
End

=> Checksum = 59H

Adjustments about RS-232 Interface

In the following commands is: x = place holder for entered and emitted values
 qq = place holder for the Checksum

Sensor Settings

Reset

Function	Send Frame to the Sensor	Response Frame from the Sensor
Reset	/000R4D.	/030R0127D.

Configure Output

Function	Send Frame to the Sensor	Response Frame from the Sensor
Configure as voltage output (0...10 V)	/020Q004C.	/030MQ0000.
Configure as current output (4 mA...20 mA)	/020Q014D.	/030MQ0101.

Choose Resolution/Speed-Mode

Function	Send Frame to the Sensor	Response Frame from the Sensor
Operate sensor with high speed (Speed-Mode)	/020er13B.	/030Mer177.
Operate sensor with high resolution (Resolution-Mode)	/020er238.	/030Mer274.

Adjustment Measuring range

Function	Send Frame to the Sensor	Response Frame from the Sensor
Teach-In zero point (0 V, 4 mA)	/020T0049.	/030MT00qq.

Function	Send Frame to the Sensor	Response Frame from the Sensor
Teach-In measuring range initial point (10 V, 20 mA)	/020T0148.	/030MTx1qq.

x = 0: Teach-In measuring range: both points acquired
 x = 1: Teach-In measuring range: one point still required

Function	Send Frame to the Sensor	Response Frame from the Sensor
Teach-In measuring range initial point (0 V, 4 mA)	/020T024B.	/030MTx2qq.

x = 0: Teach-In measuring range: both points acquired

x = 1: Teach-In measuring range: one point still required

Function	Send Frame to the Sensor	Response Frame from the Sensor
Set zero point (0 V, 4 mA)	/060pzxxxxqq.	/070Mpzxxxxqq.

xxxxx: zero point distance based on working range start in 1/100 mm

Function	Send Frame to the Sensor	Response Frame from the Sensor
Set measuring range initial point (0 V, 4 mA)	/060pbxxxxqq.	/070Mpbxxxxqq.

xxxxx: initial point 1/100 mm

Function	Send Frame to the Sensor	Response Frame from the Sensor
Set measuring range end point (10 V, 20 mA)	/060pexxxxxqq.	/070Mpexxxxxqq.

xxxxx: end point 1/100 mm

Special Settings

Set filter function

Function	Send Frame to the Sensor	Response Frame from the Sensor
Set filter	/030FSxxqq.	/030MFxxqq.

xx: Number of measurement values for average calculation

xx = 00: no filter

Optimize the exposure time

Function	Send Frame to the Sensor	Response Frame from the Sensor
Set DCM-Mode	/020eCD7F.	/030MeCD33.
Set LCM-Mode	/020eCL77.	/030MeCL3B.
Set SCM-Mode	/020eCS68.	/030MeCS24.

Switch Laser Light ON/OFF

Function	Send Frame to the Sensor	Response Frame from the Sensor
Activate Laser Light	/020L0150.	/020L0150.
Deactivate Laser Light	/020L0051.	/020L0051.

Set Delay Time of Contamination Output

Function	Send Frame to the Sensor	Response Frame from the Sensor
Set Delay Time of Contamination Output	/030fgxxqq.	/030fgxxqq.

xx = 00...99 for 1 to 99 measurements until the Error Output reacts in case of errors. The default value is 20. Attention: The duration of cycles of the number of measurements depends on the exposure time, but the delay time cannot be allocated.

Change baud rate

The baud rate of the sensor is standardized with 38400 baud. If you want to change the baud rate, proceed as follows.

Open your hyper terminal and take the following settings: Baud rate: 38400, Data bit: 8, Stop bit: 1, Parity: none, Flow control: none.

In order to change the baud rate, enter the following commands corresponding your desired baud rate.

Function	Send Frame to the Sensor	Response Frame from the Sensor
Baud rate to 9600 baud	/030?BR201.	/030Ade2qq.
Baud rate to 19200 baud	/030?BR300.	/030Ade3qq.
Baud rate to 38400 baud	/030?BR407.	/030Ade4qq.
Baud rate to 57600 baud	/030?BR506.	/030Ade5qq.
Baud rate to 115200 baud	/030?BR605.	/030Ade6qq.

The new baud rate is activated after the supply voltage is applied anew.

Query Sensor values

Function	Send Frame to the Sensor	Response Frame from the Sensor
Single Emission of object distance values	/020D0059.	/0B0D00+xxxxxumqq.

xxxxxx: Distance value in μm

Function	Send Frame to the Sensor	Response Frame from the Sensor
Activate Permanent Emission of object distance values	/020D0p19.	/040D0P:134.

Emission format like Single Emission.

Function	Send Frame to the Sensor	Response Frame from the Sensor
Deactivate Permanent Emission of object distance values	/020D0a08.	/040D0P:035.

Function	Send Frame to the Sensor	Response Frame from the Sensor
Query sensor status for Output, Teach Mode, Filter level and Error status	/000W48.	/050Wgtffeqq.

g = 0: output status for voltage output
g = 1: output status for current output
t = 0: teach mode zero point
t = 1: teach mode measuring range: one point still required
t = 2: teach mode measuring range: both points still acquired
ff = 0: Filter adjustment
e = 0: error status: no errors
e > 0: error status: error

Function	Send Frame to the Sensor	Response Frame from the Sensor
Query taught in values for initial point, if Teach Mode = measuring range	/020Wb31B.	/090Wbxxxxxumqq.

xxxxxx: Saved position for 0 V resp. 4 mA in μm

Function	Send Frame to the Sensor	Response Frame from the Sensor
Query taught in values for end point, if Teach Mode = measuring range	/020We31C.	/090Wexxxxxumqq.

xxxxxx: Saved position for 10 V resp. 20 mA in μm

Function	Send Frame to the Sensor	Response Frame from the Sensor
Query taught in values for zero point, if Teach Mode = zero point	/020Wn317.	/090Wnxxxxxumqq.

xxxxxx: Saved position for 0 V resp. 4 mA in μm

Function	Send Frame to the Sensor	Response Frame from the Sensor
Query Sensor status Resolution/Speed-Mode	/020Wrc5B.	/030Wrcxqq.

x = 1: Speed-Mode activated
x = 2: Resolution-Mode activated

Function	Send Frame to the Sensor	Response Frame from the Sensor
Query number measurement values for continuous average filter	/020WF33F	/040WF0xxqq.

xx: Number of measurement values for Average Calculation

Function	Send Frame to the Sensor	Response Frame from the Sensor
Query Sensor Version	/000V49.	/070V8a:bbccqq.

a: software version. a = 3
 bb: sensor group (2 characters) z. B. bb = 0D
 cc: sensor type (2 characters) z. B. cc = 01

Special queries

Query object distance binary

Differing from the usual query of sensor values via the protocol it is also possible to query the object distance faster through binary data.

Send a “#” sign to the sensor, then the currently measured distance value is emitted in a binary form.

Function	Send Frame to the Sensor	Response Frame from the Sensor
Emit object distance in binary form (Output value in 1/100 mm)	#	#, 16 bit binary value, e.g. #©J (means 7,69 mm object distance)

8. Maintenance Instructions

- This wenglor sensor is maintenance-free.
- It is advisable to clean the lens and the display, and to check the plug connections at regular intervals.
- Do not clean with solvents or cleansers which could damage the device.

9. Proper Disposal

wenglor sensoric gmbh does not accept the return of unusable or irreparable products. Respectively valid national waste disposal regulations apply to product disposal.

10. EU Declaration of Conformity

The EU declaration of conformity can be found on our website at www.wenglor.com in download area.