

# Quick Start Guide

**: =G!\$, ' \$ 7ca dUMW  
=bXi ghf]U GVWbbYf**



P/N 83-110830 Rev A

## GHYd ' í Dcglh]cb GVWbbYf

1. Place a test symbol in a location with as little ambient light as possible.
2. Position the scanner at the focal distance used in your application.
3. Align the test symbol with the scanner's field of view.
4. Tip the scanner relative to the test symbol to avoid glare from specular reflection.

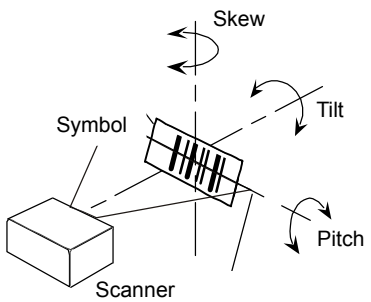

**Maximum skew, tilt, and pitch: ±30°**

## GHYd %í 7\ YWV < UfXk UfY

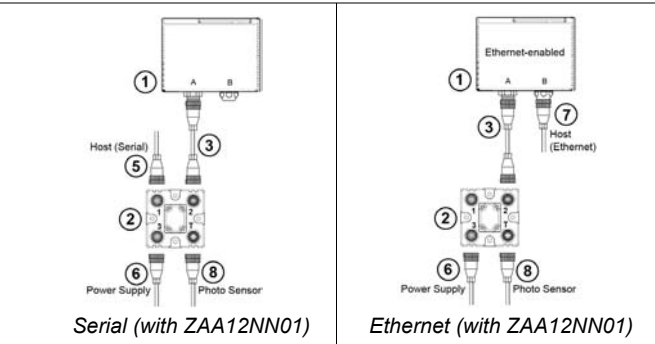

Hardware Required

**Caution:** Be sure that all connections are secure **BEFORE** applying power to the system. Always power down **BEFORE** disconnecting any cables.

Item	Description	Part Number
1	FIS-0830 Compact Industrial Scanner	FIS-0830-XXXX
2	Connection Box	ZAA12NN01
3	Cordset, Common, M12 12-pin Plug to M12 12-pin Socket	ZAV12Rx01
4	Connecting Line M12 12-pin Socket	ZAS13Rx01
5	Cordset, Host, Serial, M12 12-pin Socket to DB9	ZAV13Rx01
6	Power Supply, M12 12-pin Socket	NT10
7	Cordset, Host, Ethernet, M12 8-pin Plug to RJ45	ZAV88Rx01
8	Photo Sensor, M12 4-pin Plug, NPN	

**Note:** Additional cordsets and accessories are available in the wenglor Product Pricing List.

## GHYd ( í =bghU ``9GD

ESP Software can be found on the wenglor Tools CD that is packaged with the FIS-0830.

1. Follow the prompts to install ESP from the CD.
2. Click on the ESP icon to run the program.



**Note:** ESP can also be installed from the **Download Center** at [www.wenglor.com](http://www.wenglor.com).

Refer to the *FIS-0830 Compact Industrial Scanner User's Manual* for detailed information about using ESP to configure the FIS-0830.

## GHYd & í 7cbbYVWh Y GngHYa

**Important:** When connecting Ultra-Lock cordsets to the FIS-0830 and ZAA12NN01 align the pins first and then push the connector into place. Do not twist the connectors, as this will bend the pins.

### RS-232

1. Connect the Serial Communication Cable from "A" on the FIS-0830 to "2" on the ZAA12NN01.
2. Connect the host cable from "1" on the AB-0830 to the host computer.
3. Connect the photo sensor to "T" on the ZAA12NN01.
4. Connect the power supply to "3" on the ZAA12NN01.
5. Plug in the power supply.

### Ethernet

1. Connect the Ethernet Cable from "B" on the FIS-0830 to the network.
2. Connect the power supply to "A" on the FIS-0830.
3. Plug in the power supply.

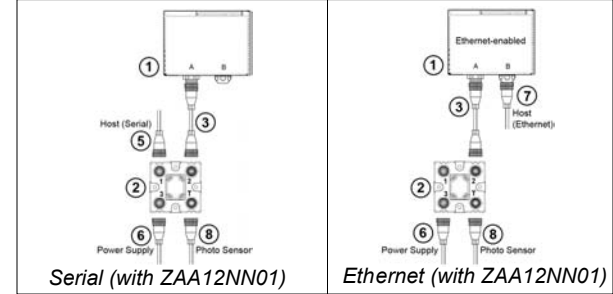

## GHYd ) í GY'YVhA cXY

When you start ESP, the model menu will appear:



1. Click the button showing the FIS-0830.
  2. Click **OK**.
- Note:** You can also simply double-click the button showing your scanner to make your selection.
3. Click **Yes** when this dialog appears:

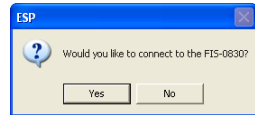

**Note:** If you need to select another model later, click the **Switch Model** button near the top of the screen or use **Model > New Model** in the menu toolbar.

# Step 6 — Connect

**RS-232**  
To connect using the Connection Wizard:

- Click **Connect** on the menu toolbar, and then select **Connection Wizard**.
- Select **RS-232**.
- Configure RS-232 settings as required by the application, and click **Connect**.



- When a connection is established, the green indicator in the status bar at the bottom right of the screen will be visible:

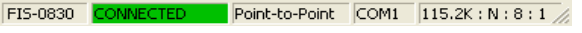

**Important:** The scanner is in **Continuous Read Mode** by default. For best connection results, be sure that no decodable symbols are within the scanner's field of view while attempting to connect.

# Step 6 — Connect (cont.)

**Ethernet TCP/IP**  
To connect using the Connection Wizard:

- Click **Connect** on the menu toolbar, and then select **Connection Wizard**.
- Select **Ethernet**.
- Configure Ethernet settings as required by the application, and click **Connect**.

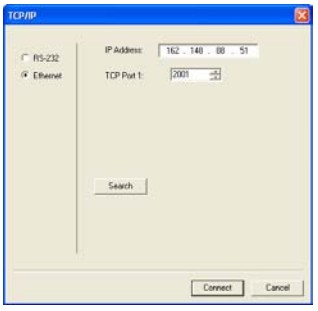

- When a connection is established, the green indicator in the status bar at the bottom right of the screen will be visible:

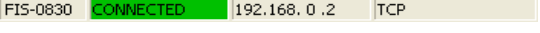

**Important:** The scanner is in **Continuous Read Mode** by default. For best connection results, be sure that no decodable symbols are within the scanner's field of view while attempting to connect.

# Step 6 — Connect (cont.)

**Ethernet TCP/IP (cont.)**  
When the FIS-0830 is connected, incoming symbol data can be displayed in the **Terminal**, as shown below.

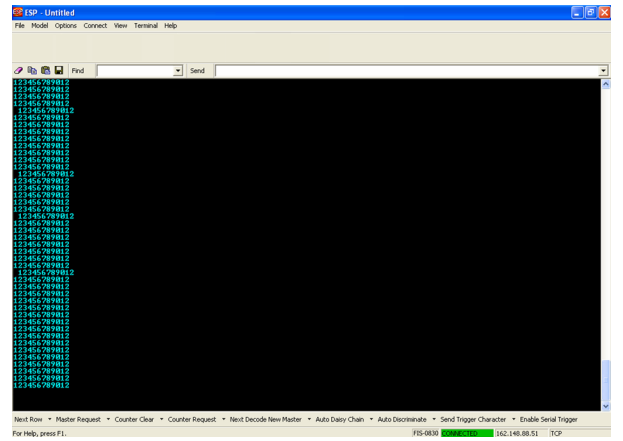

# Step 7 — Test Read Rate

**Read Rate** indicates the number or percentage of successful decodes per second achieved by the scanner.

- Click the **Test** button in ESP's **EZ Mode** to start the Read Rate test. Symbol data and read rate percentage information should appear in the **Symbol Information** table. The Read Rate LEDs on the side of the FIS-0830 will indicate the percentage of successful decodes per second.
- Click **Stop** to end the Read Rate test. **Note:** Read Rate can also be tested using the **Read Rate** interface in **Utilities**.

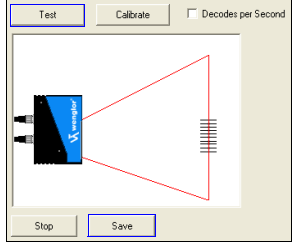

Refer to the *FIS-0830 Compact Industrial Scanner User's Manual* for information about how to test read rate using serial commands or the scanner's EZ button.

# Step 8 — Configure the Scanner

Click the **App Mode** button to make configuration changes to the scanner.



The following modes are accessible by clicking the buttons at the top of the screen:



- Click the **EZ Mode** button to return to EZ Mode.
- Click the **Autoconnect** button to establish communications.
- Click the **Send/Recv** button to send or receive commands.
- Click the **Switch Model** button to open the model menu, or to return to the previous model.
- Click the **Parameters** button to show the tabbed tree control views.
- Click the **Setup** button to show the tabbed interface views.
- Click the **Terminal** button to display decoded symbol data and to send serial commands.
- Click the **Utilities** button to access Read Rate, Counters, Device Control, Differences from Default, Master Database, Digital Bar Code, and Firmware.

For further details, see **Microscan ESP Help** in the dropdown Help menu.

# Step 9 — Save Changes

To make changes to configuration settings in the tree controls:

- Left-click on the **+** to expand the desired tree.
- Double-click on the desired parameter and click once in the selection box to view options.
- Place your cursor in the selection box, scroll down to the setting you want to change, and click once on the setting.
- Left-click on the open screen to complete your selection.
- Right-click on the open screen and select **Save to Reader** to implement the command in the scanner.

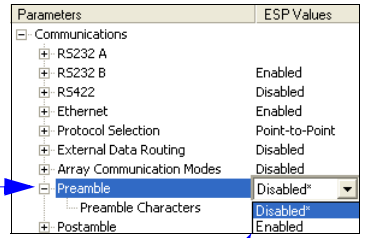

**Saving Options**

- Send, No Save.** Changes will be lost when power is re-applied to the scanner.
- Send and Save.** This activates all changes in current memory and saves to the scanner for power-on.