

**INTERRUTTORE DI PROSSIMITA'
CAPACITIVO FILETTATO CON
CUSTODIA PLASTICA
IN C.C. E C.A.**

**SERIE
*SERIES***

K14

***CAPACITIVE PROXIMITY SWITCHES
THREADED WITH PLASTIC BODY
D.C. AND A.C. TYPE***

**INTERRUTTORI DI PROSSIMITA' CAPACITIVI FILETTATO
CON CUSTODIA PLASTICA IN C.C. E C.A.
CAPACITIVE PROXIMITY SWITCHES
THREADED WITH PLASTIC BODY D.C. AND A.C. TYPE**



- ⇒ INTERRUTTORI DI PROSSIMITA' CILINDRICI
CAPACITIVI DIAMETRI 18 - 22 - 30 - 32 - 50 mm
- ⇒ USCITA CAVO O CONNETTORE M12
- ⇒ ALIMENTAZIONE IN C.C. 10 ÷ 30 Vcc
- ⇒ ALIMENTAZIONE IN C.A. 20 ÷ 230 Vca
- ⇒ ALIMENTAZIONE IN C.C./ C.A. 20 ÷ 230 Vcc/ Vca

- ⇒ CAPACITIVE CYLINDRICAL PROXIMITY SWITCHES
18, 22, 30, 32, 50 mm DIAMETER
- ⇒ CABLE OUTPUT OR M12 CONNECTOR OUTPUT
- ⇒ D.C. 10 ÷ 30 Vdc SUPPLY VERSIONS
- ⇒ A.C. 20 ÷ 230 Vac SUPPLY VERSIONS
- ⇒ D.C./A.C. 20 ÷ 230 Vdc/ Vac SUPPLY VERSIONS

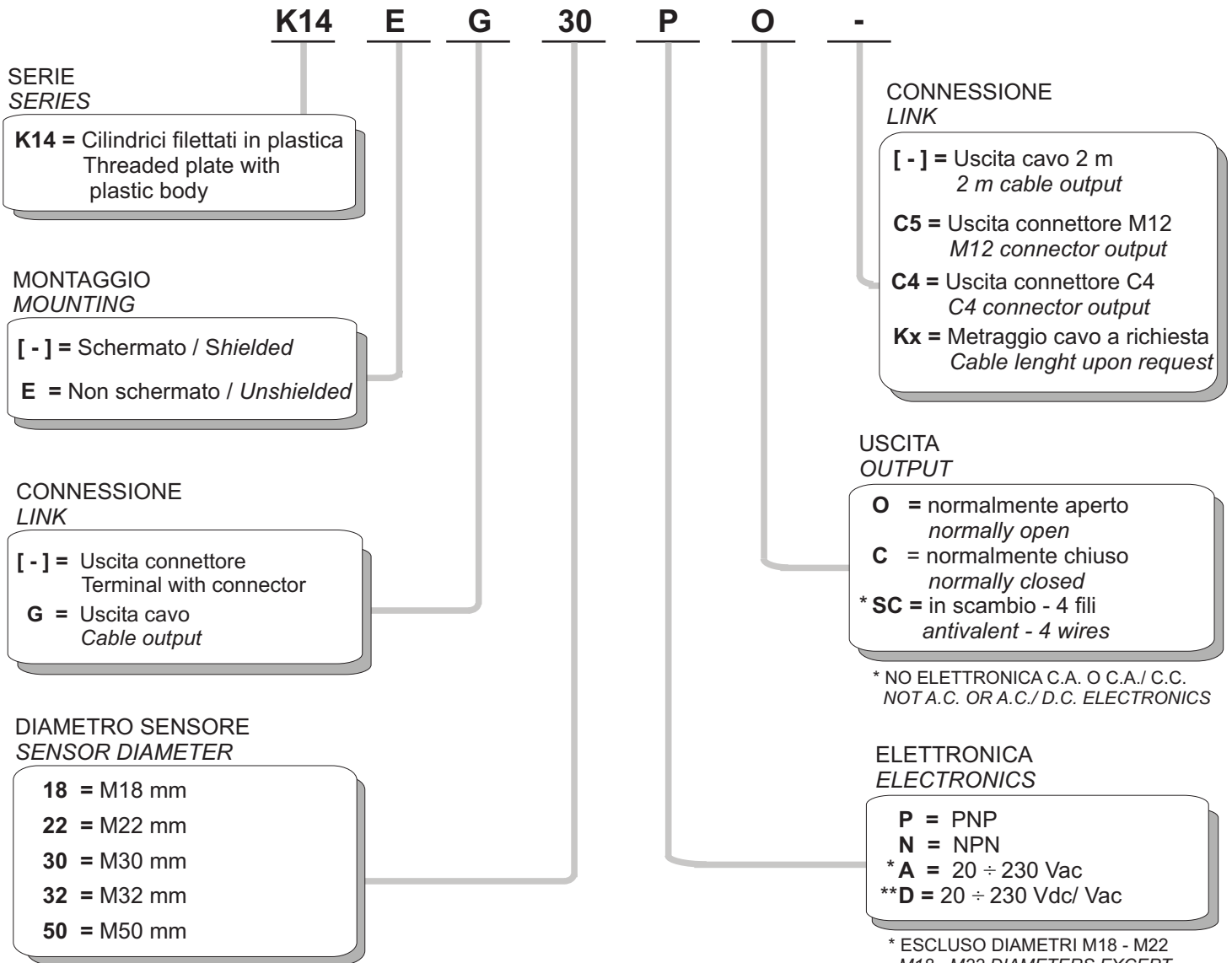
COME ORDINARE
HOW TO ORDER

PLEASE NOTE: this matrix is intended only to aid you in identifying sensor catalog listing. It is not all-inclusive and must not be used to form new listings.
NOTA BENE: questo schema è fornito solo per aiutare a identificare le caratteristiche dei prodotti a catalogo. Non è onnicomprensivo e pertanto non deve essere usato per creare nuovi riferimenti di prodotti.

File Name: k14.cdr
Rev: 0.9 Date: 01/03/17

La Ditta costruttrice si riserva di apportare qualunque modifica ritenga utile senza preavviso.
Manufacturer reserve itself all the rights to change without notice.

CARATTERISTICHE ELETTRICHE
ELECTRICAL FEATURES
VERSIONE IN C.C.
D.C TYPE

ALIMENTAZIONE	10 ÷ 30 Vcc/Vdc	<i>SUPPLY VOLTAGE</i>
ONDULAZIONE RESIDUA	< 10%	<i>RIPPLE</i>
ASSORBIMENTO	< 15 mA	<i>POWER CONSUMPTION</i>
CARICO MASSIMO	200 mA	<i>MAXIMUM LOAD</i>
CADUTA DI TENSIONE	< 3 V @ 200 mA	<i>VOLTAGE DROP</i>
PROTEZIONE C.C.	SI / YES	<i>SHORT CIRCUIT PROTECTION</i>
PROTEZIONE INVERS. POLARITA'	SI / YES	<i>REVERSE POLARITY PROTECTION</i>
LED DI SEGNALAZIONE	SI / YES	<i>OUTPUT STATUS LED</i>
COMPATIBILITA' ELETTROMAGNETICA CE	EN60947-5-2	<i>CE COMPLIANCE</i>
CERTIFICAZIONE	CE	<i>CERTIFICATION</i>

VERSIONE IN C.A.
A.C. TYPE

ALIMENTAZIONE	20 ÷ 230 Vca/Vac	<i>SUPPLY VOLTAGE</i>
ONDULAZIONE RESIDUA	-	<i>RIPPLE</i>
ASSORBIMENTO	< 2,5 mA	<i>POWER CONSUMPTION</i>
CARICO MASSIMO	15 ÷ 400 mA	<i>MAXIMUM LOAD</i>
CADUTA DI TENSIONE	< 6 Vac	<i>VOLTAGE DROP</i>
PROTEZIONE C.C.	NO	<i>SHORT CIRCUIT PROTECTION</i>
LED DI SEGNALAZIONE	SI / YES	<i>OUTPUT STATUS LED</i>
COMPATIBILITA' ELETTROMAGNETICA CE	EN60947-5-2	<i>CE COMPLIANCE</i>
CERTIFICAZIONE	CE	<i>CERTIFICATION</i>

VERSIONE IN C.C./ C.A.
D.C./ A.C. TYPE

ALIMENTAZIONE	20 ÷ 230 Vcc/Vca Vdc/Vac	<i>SUPPLY VOLTAGE</i>
ONDULAZIONE RESIDUA	-	<i>RIPPLE</i>
ASSORBIMENTO	< 2,3 mA	<i>POWER CONSUMPTION</i>
CARICO MASSIMO	10 ÷ 400 mA	<i>MAXIMUM LOAD</i>
CADUTA DI TENSIONE	< 6 V	<i>VOLTAGE DROP</i>
PROTEZIONE C.C.	NO	<i>SHORT CIRCUIT PROTECTION</i>
LED DI SEGNALAZIONE	SI / YES	<i>OUTPUT STATUS LED</i>
COMPATIBILITA' ELETTROMAGNETICA CE	EN60947-5-2	<i>CE COMPLIANCE</i>
CERTIFICAZIONE	CE	<i>CERTIFICATION</i>

CARATTERISTICHE TECNICHE
TECHNICAL FEATURES
SENSORI DIAMETRO 18 mm
18 mm DIAMETER SENSORS

	M18		
SCHERMATO	•		<i>SHIELDED (FLUSH)</i>
NON SCHERMATO			<i>UNSHIELDED (NO FLUSH)</i>
DISTANZA D'INTERVENTO - S _n	1 ÷ 8 mm	2 ÷ 15 mm	<i>S_n - SENSING DISTANCE</i>
DISTANZA REALE	± 10% S _n		<i>REAL DISTANCE</i>
ISTERESI	≤ 10% S _n		<i>HYSTERESIS</i>
RIPETIBILITÀ	< 10% S _n		<i>REPEATABILITY</i>
FREQUENZA MASSIMA	100 Hz		<i>MAX. SWITCHING FREQUENCY</i>
TEMPERATURA DI LAVORO	-25°C ÷ +70°C		<i>WORKING TEMPERATURE</i>
MATERIALE CORPO	PLASTICO (ABS)		<i>BODY MATERIAL</i>
PROTEZIONE	IP65(con connettore montato/with connector mounted)		<i>PROTECTION RATING</i>
CAVO	3x0,35 mm ² 4x0,35 mm ²		<i>CABLE</i>

SENSORI DIAMETRO 22 mm
22 mm DIAMETER SENSORS

	M22		
NON SCHERMATO	•		<i>UNSHIELDED (FLUSH)</i>
DISTANZA D'INTERVENTO - S _n	2 ÷ 20 mm		<i>SENSING DISTANCE</i>
DISTANZA REALE	± 10% S _n		<i>REAL DISTANCE</i>
ISTERESI	2 ÷ 15% S _n		<i>HYSTERESIS</i>
RIPETIBILITÀ	< 10% S _n		<i>REPEATABILITY</i>
FREQUENZA MASSIMA	100 Hz		<i>MAX. SWITCHING FREQUENCY</i>
TEMPERATURA DI LAVORO	-25°C ÷ +70°C		<i>WORKING TEMPERATURE</i>
MATERIALE CORPO	PLASTICO (ABS)		<i>BODY MATERIAL</i>
PROTEZIONE	IP65 (con connettore montato/with connector mounted)		<i>PROTECTION RATING</i>
CAVO	3x0,35 mm ² 4x0,35 mm ²		<i>CABLE</i>
CONNETTORE M12 (C5)	C5-C6-C7-L7-C9-L9		<i>(C5) M12 CONNECTOR</i>

SENSORI DIAMETRO 30 mm
30 mm DIAMETER SENSORS

	M30			
SCHERMATO	•			<i>SHIELDED (FLUSH)</i>
NON SCHERMATO				<i>UNSHIELDED (NO FLUSH)</i>
DISTANZA D'INTERVENTO - S _n	2 ÷ 20 mm	3 ÷ 30 mm	2 ÷ 25 mm (CC/CA)	<i>S_n - SENSING DISTANCE</i>
DISTANZA REALE	± 10% S _n			<i>REAL DISTANCE</i>
ISTERESI	2 ÷ 15% S _n			<i>HYSTERESIS</i>
RIPETIBILITÀ	≤ 10% S _n			<i>REPEATABILITY</i>
FREQUENZA MASSIMA	100 Hz		10 Hz (CC/CA)	<i>MAX. SWITCHING FREQUENCY</i>
TEMPERATURA DI LAVORO	-25°C ÷ +70°C			<i>WORKING TEMPERATURE</i>
MATERIALE CORPO	PLASTICO (ABS)			<i>BODY MATERIAL</i>
PROTEZIONE	IP65(con connettore montato/with connector mounted)			<i>PROTECTION RATING</i>
CAVO	2x0,35 mm ² 3x0,35 mm ² 4x0,35 mm ²			<i>CABLE</i>
CONNETTORE M12 (C5)	C5-C6-C7-L7-C9-L9			<i>(C5) M12 CONNECTOR</i>
CONNETTORE ALTRO TIPO	C4			<i>C4 CONNECTOR</i>

SENSORI DIAMETRO 32 mm
32 mm DIAMETER SENSORS

	M32	
NON SCHERMATO	•	<i>UNSHIELDED (NO FLUSH)</i>
DISTANZA D'INTERVENTO - Sn	3 ÷ 30 mm	<i>SENSING DISTANCE</i>
DISTANZA REALE	± 10% Sn	<i>REAL DISTANCE</i>
ISTERESI	2 ÷ 15% Sn	<i>HYSTERESIS</i>
RIPETIBILITÀ	≤ 10% Sn	<i>REPEATABILITY</i>
FREQUENZA MASSIMA	60 Hz	<i>MAX. SWITCHING FREQUENCY</i>
TEMPERATURA DI LAVORO	-25°C ÷ +70°C	<i>WORKING TEMPERATURE</i>
MATERIALE CORPO	PLASTICO (ABS)	<i>BODY MATERIAL</i>
PROTEZIONE	IP65 (con connettore montato/with connector mounted)	<i>PROTECTION RATING</i>
CAVO	2x0,35 mm ² 3x0,35 mm ² 4x0,35 mm ²	<i>CABLE</i>
CONNETTORE M12 (C5)	C5-C6-C7-L7-C9-L9	<i>(C5) M12 CONNECTOR</i>

SENSORI DIAMETRO 50 mm
50 mm DIAMETER SENSORS

	M50	
NON SCHERMATO	•	<i>UNSHIELDED (NO FLUSH)</i>
DISTANZA D'INTERVENTO - Sn	4 ÷ 50 mm	<i>Sn - SENSING DISTANCE</i>
DISTANZA REALE	± 10% Sn	<i>REAL DISTANCE</i>
ISTERESI	2 ÷ 15% Sn	<i>HYSTERESIS</i>
RIPETIBILITÀ	≤ 10% Sn	<i>REPEATABILITY</i>
FREQUENZA MASSIMA	60 Hz	<i>MAX. SWITCHING FREQUENCY</i>
TEMPERATURA DI LAVORO	-25°C ÷ +70°C	<i>WORKING TEMPERATURE</i>
MATERIALE CORPO	PLASTICO (ABS)	<i>BODY MATERIAL</i>
PROTEZIONE	IP65(con connettore montato/with connector mounted)	<i>PROTECTION RATING</i>
CAVO	2x0,35 mm ² 3x0,35 mm ² 4x0,35 mm ²	<i>CABLE</i>

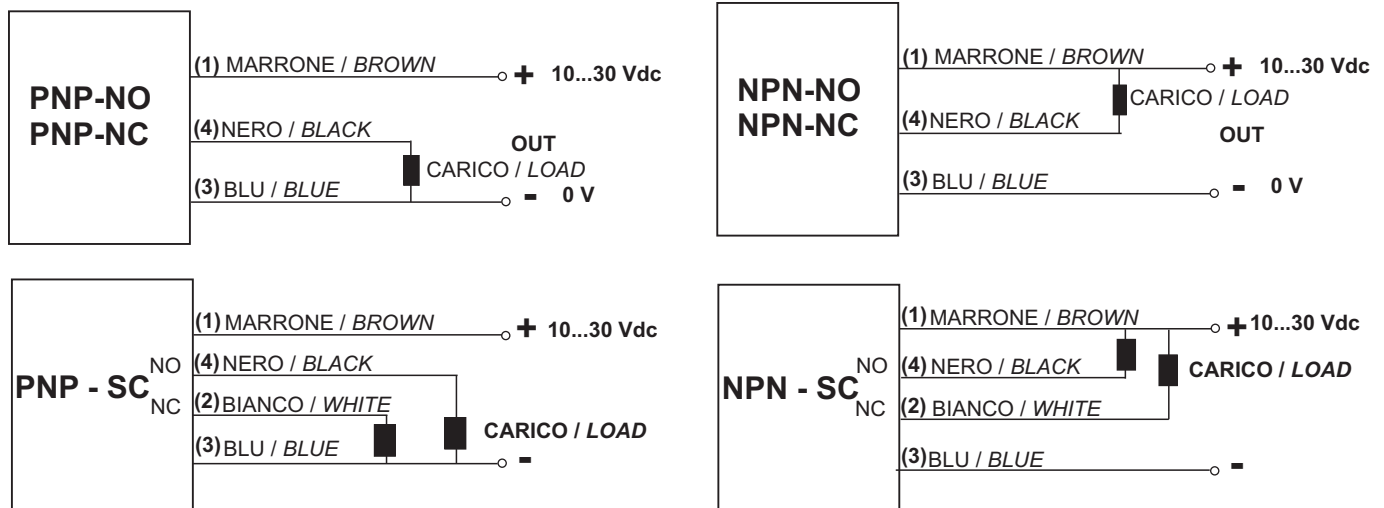
COLLEGAMENTI
CONNECTIONS
3/4 FILI C.C. / D.C. 3/4WIRES

**CONNETTORE M12 (C5) (C.C.) /
(C5) M12 CONNECTOR (D.C.)**

1 + MARRONE / BROWN
4 OUT NERO / BLACK
3 - BLU / BLUE

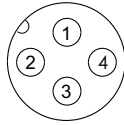

1 + MARRONE / BROWN
2 NC OUT BIANCO/WHITE
3 - BLU / BLUE
4 NO OUT NERO / BLACK

C5-C6-C7-L7 CC/DC

C5-C6-C9-L9 CC/DC

**CONNETTORE M12 (C5) (C.A.) /
(C5) M12 CONNECTOR (A.C.)**

1 ~ MARRONE / BROWN
2/3 ~ BLU/BLUE
4* ⚡ GIALLO-VERDE/
YELLOW-GREEN

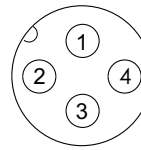

* FILO NON PRESENTE NEI MODELLI CON
CONTENITORE METALLICO + USCITA CONN. M12

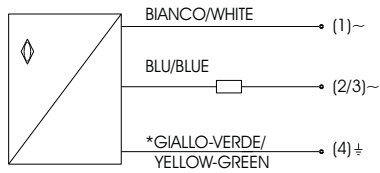
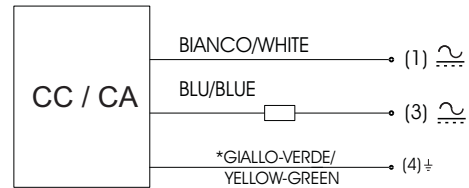
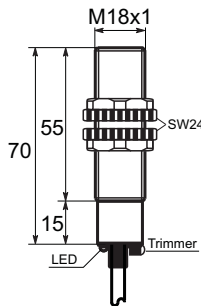
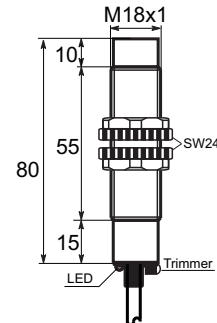
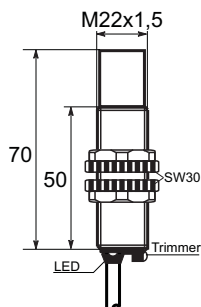
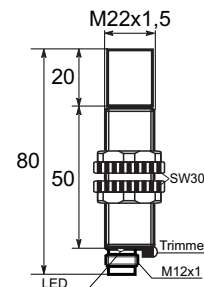
3/4 FILI C.A. A.C. 3/4 WIRES

3 FILI C.C./C.A. D.C./A.C. 3 WIRES

DIMENSIONI MECCANICHE
MECHANICAL SIZE
DIAMETRO 18 mm
18 mm DIAMETER
K14G18_

K14EG18_

DIAMETRO 22 mm
22 mm DIAMETER
K14EG22_

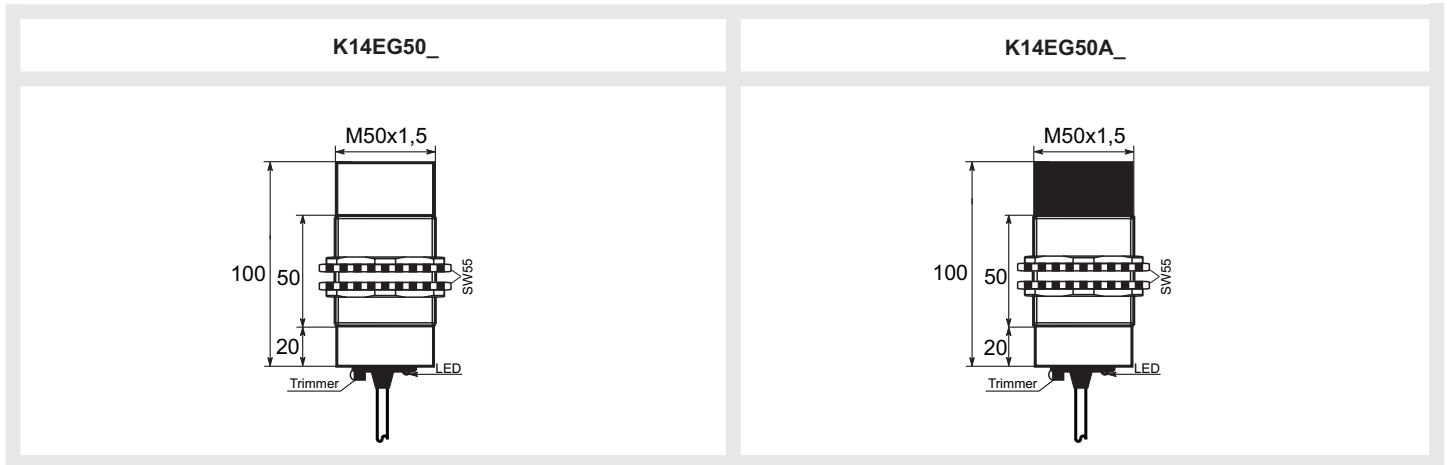
K14E22_C5

DIAMETRO 30 mm
30 mm DIAMETER

K14G30_ 	K1430_C5 	K14EG30_ 	K14E30_C5 	K14G30A_ 	K14EG30A_
K14G30D_ 	K1430D_C5 	K14EG30D_ 	K14E30D_C5 	K14E30D_C4 	

DIAMETRO 32 mm
32 mm DIAMETER

K14EG32_ 	K14E32_C5 	K14EG32A_ 	K14E32A_C5 	K14EG32D_ 	K14E32D_C5
---------------------	----------------------	----------------------	-----------------------	----------------------	-----------------------

DIAMETRO 50 mm
50 mm DIAMETER

ELENCO PRODOTTI
PRODUCTS LIST
DIAMETRO 18 mm
18 mm DIAMETER

	USCITA CAVO / CABLE OUTPUT			
	SCHERMATO SHIELDED	NON SCHERMATO UNSHIELDED		
PNP-NO	K14G18PO	K14EG18PO		
PNP-NC	K14G18PC	K14EG18PC		
PNP-SC	K14G18PSC	K14EG18PSC		
NPN-NO	K14G18NO	K14EG18NO		
NPN-NC	K14G18NC	K14EG18NC		
NPN-SC	K14G18NSC	K14EG18NSC		
C.A. NO	-	-		
C.A. NC	-	-		

DIAMETRO 22 mm
22 mm DIAMETER

	USCITA CAVO / CABLE OUTPUT		USCITA CONNETTORE M12 / M12 CONNECTOR OUTPUT	
		NON SCHERMATO / UNSHIELDED		NON SCHERMATO / UNSHIELDED
PNP-NO	-	K14EG22PO	-	K14E22POC5
PNP-NC	-	K14EG22PC	-	K14E22PCC5
PNP-SC	-	K14EG22PSC	-	K14E22PSCC5
NPN-NO	-	K14EG22NO	-	K14E22NOC5
NPN-NC	-	K14EG22NC	-	K14E22NCC5
NPN-SC	-	K14EG22NSC	-	K14E22NSC5

DIAMETRO 30 mm
30 mm DIAMETER

	USCITA CAVO / CABLE OUTPUT		USCITA CONNETTORE M12 / M12 CONNECTOR OUTPUT		USCITA CONNETTORE C4 / C4 CONNECTOR OUTPUT	
	SCHERMATO /SHIELDED	NON SCHERMATO/ UNSHIELDED	SCHERMATO/ SHIELDED	NON SCHERMATO/ UNSHIELDED	SCHERMATO /SHIELDED	NON SCHERMATO/ UNSHIELDED
PNP-NO	K14G30PO	K14EG30PO	K1430POC5	K14E30POC5	-	-
PNP-NC	K14G30PC	K14EG30PC	K1430PCC5	K14E30PCC5	-	-
PNP-SC	K14G30PSC	K14EG30PSC	K1430PSCC5	K14E30PSCC5	-	-
NPN-NO	K14G30NO	K14EG30NO	K1430NOC5	K14E30NOC5	-	-
NPN-NC	K14G30NC	K14EG30NC	K1430NCC5	K14E30NCC5	-	-
NPN-SC	K14G30NSC	K14EG30NSC	K1430NSCC5	K14E30NSCC5	-	-
C.A. NO	K14G30AO	K14EG30AO	-	-	-	-
C.A. NC	K14G30AC	K14EG30AC	-	-	-	-
C.A./C.C. NO	K14G30DO	K14EG30DO	K1430DOC5	K14E30DOC5	-	K14E30DOC4
C.A./C.C. NC	K14G30DC	K14EG30DC	K1430DCC5	K14E30DCC5	-	K14E30DCC4

DIAMETRO 32 mm
32 mm DIAMETER

	USCITA CAVO / CABLE OUTPUT		USCITA CONNETTORE M12 / M12 CONNECTOR OUTPUT			
		NON SCHERMATO/ UNSHIELDED		NON SCHERMATO/ UNSHIELDED		
PNP-NO	-	K14EG32PO	-	K14E32POC5	-	-
PNP-NC	-	K14EG32PC	-	K14E32PCC5	-	-
PNP-SC	-	K14EG32PSC	-	K14E32PSCC5	-	-
NPN-NO	-	K14EG32NO	-	K14E32NOC5	-	-
NPN-NC	-	K14EG32NC	-	K14E32NCC5	-	-
NPN-SC	-	K14EG32NSC	-	K14E32NSCC5	-	-
C.A. NO	-	K14EG32AO	-	K14E32AOC5	-	-
C.A. NC	-	K14EG32AC	-	K14E32ACC5	-	-
C.A./C.C. NO	-	K14EG32DO	-	K14E32DOC5	-	-
C.A./C.C. NC	-	K14EG32DC	-	K14E32DCC5	-	-

DIAMETRO 50 mm
50 mm DIAMETER

	USCITA CAVO / CABLE OUTPUT					
		NON SCHERMATO/ UNSHIELDED				
PNP-NO	-	K14EG50PO	-	-	-	-
PNP-NC	-	K14EG50PC	-	-	-	-
PNP-SC	-	K14EG50PSC	-	-	-	-
NPN-NO	-	K14EG50NO	-	-	-	-
NPN-NC	-	K14EG50NC	-	-	-	-
NPN-SC	-	K14EG50NSC	-	-	-	-
C.A. NO	-	K14EG50AO	-	-	-	-
C.A. NC	-	K14EG50AC	-	-	-	-

Altri prodotti

- interruttori di prossimità induttivi;
- interruttori di prossimità capacitivi;
- interruttori di prossimità magnetici;
- interruttori di prossimità fotoelettrici;
- interruttori di prossimità ad ultrasuoni;

- connettori e cassette di connessione per sensori;

- encoder incrementali ed assoluti;

- alimentatori / interfacce per sensori;
- alimentatori da rete e da secondario per uso generico;

- voltmetri, amperometri, contagiri, visualizzatori a pannello;
- contaimpulsi mono e bidirezionali, contaproduzione, contagiri;
- termometri e termoregolatori

- schede logiche programmabili per uso OEM;

- pulsanteria e finecorsa meccanici;

Other products:

- *inductive proximity switches;*
- *capacitive proximity switches;*
- *magnetic proximity switches;*
- *photo-electric sensors & proximity switches;*
- *ultrasonic proximity switches;*

- *connectors & connection boxes for sensor;*

- *incremental & absolute encoders;*

- *supply units / interfaces for sensors;*
- *power supply units for general purpose;*

- *voltmeters, ammeters, revolution counters, panel displays;*
- *counters mono & bi-directional, timers, revolution counters;*
- *thermometers & temperature controllers;*

- *OEM programmable logic cards;*

- *push-button & mechanical limit switches;*