

Data Sheet for Precision Potentiometer

Singleturn Wirewound Potentiometer

Series RP22/23



The RP22/23 potentiometers in 22 mm metal housing are suitable for applications where an accurate and compact sensor with high electrically effective rotation angle is required.

- Accurate wirewound potentiometer
- With or without mechanical end stop (320° / 360°)
- Very high electrically effective angle of rotation 355° ±5°
- Compact sensor with 12 mm installation depth
- With many options

The RP22/23 potentiometer series (RP23 with mechanical end stop) is a multitalent which is adaptable for a wide range of applications and is often used as a feedback sensor in valve control systems. In addition, the sensor convinces by its very good accuracy.

Electrical Data	RP23	RP22
Effective electrical angle of rotation 1.)	320° ±5°	355° ±5°
Total resistance 1.)	10 Ohm..20 kOhm	
Resistance tolerance	±3% (±1%)	
Independent linearity (best straight line) 1.)	±0,3% (±0,25% R > 1kOhm)	
Theoretical resolution 1.)	Depends on resistance value (see table below)	
Backlash (Hysteresis) 1.)	≤ 0,5°	
Rotational noise (ENR) 1.) (Method C)	100 Ohm	
Max. / recommended wiper current 1.)	35 mA / 2 µA	
Power rating @ 70°C (0W @ 105°C)	0,5 W	
Insulation Voltage 1.)	1000 VAC, 1min	
Insulation Resistance 1.)	1000 MOhm @ 1000 VDC	

Mechanical Data, Environmental Conditions, Miscellaneous	RP23	RP22
Mechanical angle of rotation	320° +10° with stop	360° without stop
Lifetime (90% el. eff. angle half sine) 2.)	1 Mio. rotations	
Max. operational speed	40 rev. / min.	
Bearing	Sleeve bearing	
Operational torque @ ambient temperature 1.) 2.)	5 Nmm	
End stop torque 1.) 2.)	90 Ncm	-
Operating temperature range	-20..+105°C	
Storage temperature range	-55..+105°C	
Protection grade (IEC 60529)	IP40	
Protection option D shaft sealing (IEC 60529)	IP65 optional	
Vibration (IEC 68-2-6, Test Fc)	15g 10..2000Hz x 12h	
Shock (IEC 68-2-27, Test Ea)	49g @ 11 ms x 18	
Housing diameter	22 mm	
Housing depth	12 mm	
Shaft diameter	6 mm (optional 6,35 mm)	
Shaft type	Solid shaft	

Data Sheet for Precision Potentiometer

Singleturn Wirewound Potentiometer

Series RP22/23

Mechanical Data, Environmental Conditions, Miscellaneous	RP23	RP22
Max. radial load		≤1 N
Max. axial load		≤1 N
Connection type	Gold plated soldering lugs	
Connection position	Axial	
Sensor mounting	Bushing	
Mass	30 g	
Fastening parts included in delivery	Nut, toothed washer	
Fastening torque mounting nut	150 Ncm	
Material shaft	Stainless steel	
Material housing	Metal	

1.) According IEC 60393

2.) Determined by climatic conditions according to IEC 68-1, para. 5.3.1 without load collectives

Please note: Max. permissible supply voltage <75 VDC respectively <50 VAC in addition the max. power rating must be observed

Number of wire turns / resolution									
Resistance value Ohm	50	100	200	500	1k	2k	5k	10k	20k
Number of wire turns	300	370	470	450	570	740	1000	1270	1670
Resolution in % (100% / number of turns)	0,333	0,27	0,213	0,222	0,1754	0,135	0,1	0,079	0,599

Data Sheet for Precision Potentiometer

Singleturn Wirewound Potentiometer

Series RP22/23

Order code									
Description		Selection: standard=black/bold, possible options=grey/cursive							
Series	RP								
Angle of rotation mecha.:									
Without stop		22							
With stop		23							
Resistance value:									
Option 10 Ohm			R10						
Option 20 Ohm			R20						
Option 50 Ohm			R50						
Option 100 Ohm			R100						
Option 200 Ohm			R200						
Option 500 Ohm			R500						
1 kOhm			R1k						
Option 2 kOhm			R2k						
5 kOhm			R5k						
10 kOhm			R10k						
Option 20 kOhm			R20k						
Option rear shaft:									
Standard Ø3,00 x 20 mm				RA					
Shaft length in mm				RAxx,xx					
Shaft diameter in mm (≤3 mm)				RADMx,xx					
Resistance tolerance:									
±3%					W3%				
Option ±1%					W1%				
Independent linearity:									
±0,3%						L0,3%			
Option ±0,25% R > 1kOhm						L0,25%			
Option center tap:							CT		
Front shaft:									
Standard Ø6,00 x 22 mm							-		
Option front shaft diameter Ø6,35 mm							DM6,35		
Option shaft length in mm							Ax,xx		
Option shaft diameter in mm (≤6,35 mm)							DMx,xx		
Option screwdriver slot:								B	
Shaft sealing:									
Standard is without sealing									-
Option D with shaft sealing									D

For higher quantities or on-going demand, additional options are available as described below on request

For Example: Sealed housing case, special electrical and mechanical angles of rotation, and special resistance and linearity tolerances. Furthermore we can mount gear wheels or attach cable assemblies with or without connectors and much more.

Data Sheet for Precision Potentiometer



Singleturn Wirewound Potentiometer

Series RP22/23

Drawing

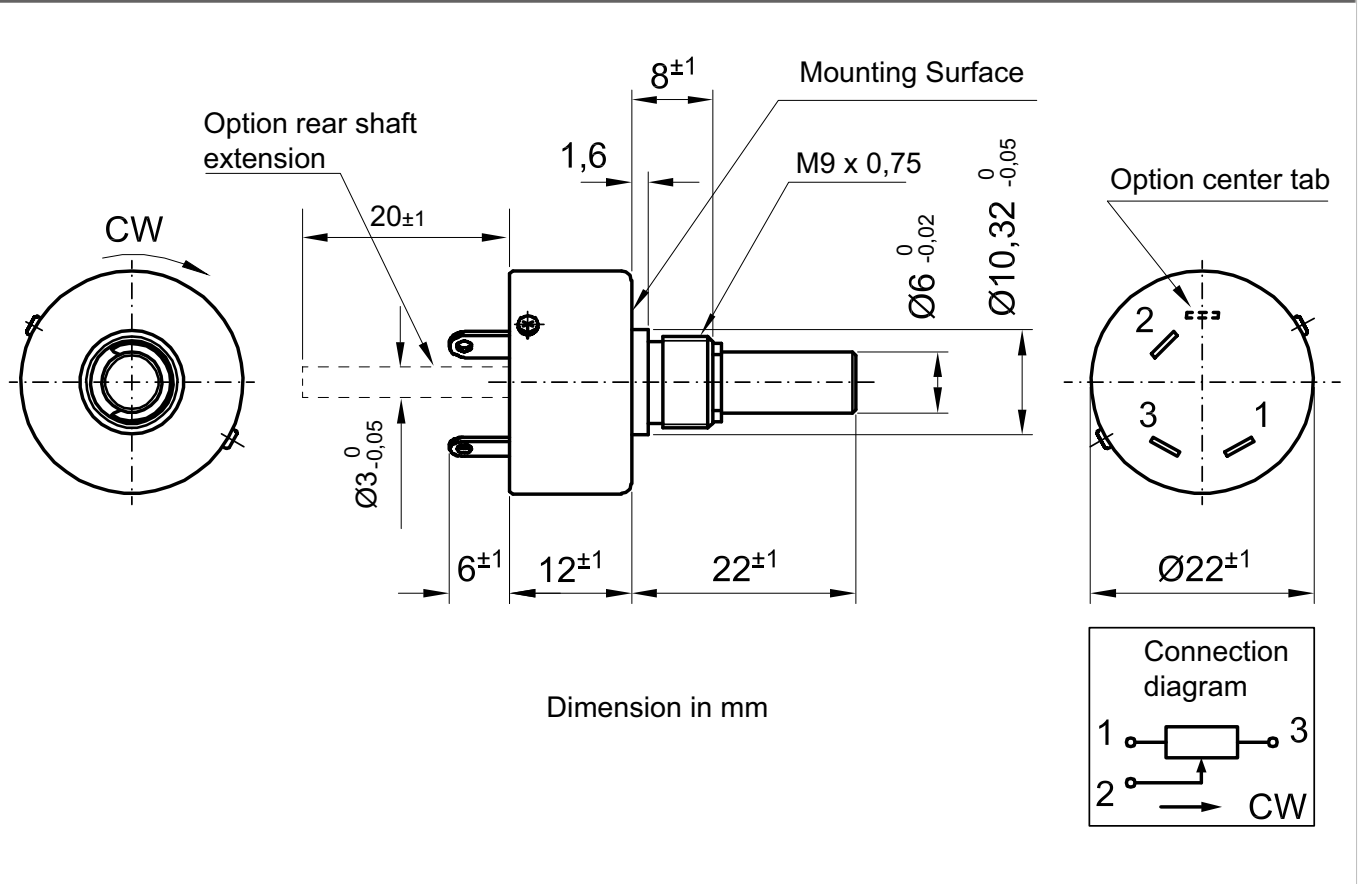

On Request: Special machining on shaft

Slot



Groove

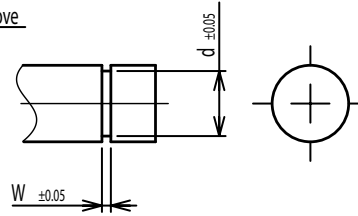

Flat



Round top

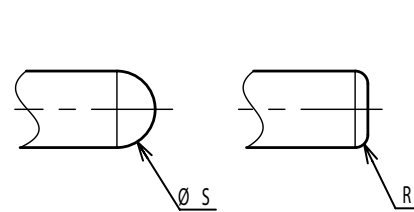

Double side flat



Counterbore hole

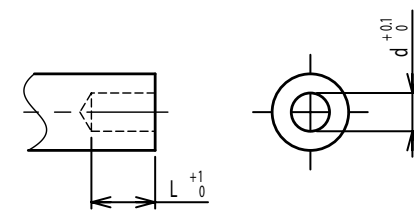

Step



Counterbore screw hole

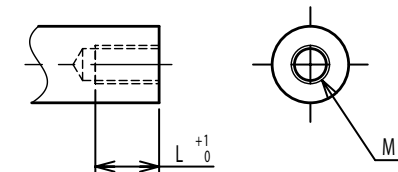

Screw Thread

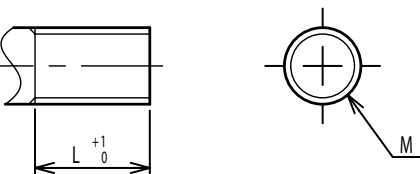

Pin hole

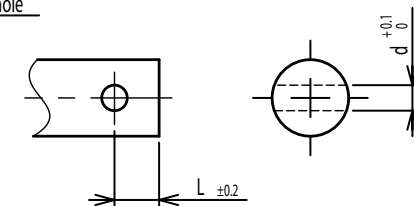

Knurled(Parallel)

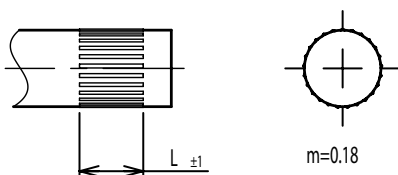

Screw thread inside hole

