

Data Sheet for Precision Potentiometer

Singleturn Wirewound Potentiometer

Series MUP



The MUP potentiometers in 22 mm housing are suitable for applications in which a compact sensor with good quality and reasonable price is important

- Economical and universal potentiometer
- Compact with only 8.6 mm housing depth
- With mechanical end stop (320° / 270°)
- Potentiometer with many options

Models with electrical rotation angle of 320° (MUP1300/1350) and 270° (MUP1307) are available.

Electrical Data	MUP1300	MUP1350	MUP1307
Effective electrical angle of rotation 1.)	320° ±5°		270° ±5°
Total resistance 1.)	0,1..10 kOhm		
Resistance tolerance	±10%	±5%	±10%
Independent linearity (best straight line) 1.)	±1%	±0,5%	±1%
Theoretical resolution	Depends on resistance value		
Rotational noise (ENR) 1.) (Method C)	100 Ohm		
Max. / recommended wiper current 1.)	34 mA / 1 µA		
Power rating @ 70°C (0W @ 105°C)	1,5 W		
Insulation Resistance 1.)	1000 MOhm @ 500 VDC		

Mechanical Data, Environmental Conditions, Miscellaneous	MUP1300	MUP1350	MUP1307
Mechanical angle of rotation	320° +10° with stop		270° +10° with stop
Lifetime (90% el. eff. angle half sine) 2.)	400.000 rotations		
Max. operational speed	10 rev. / min.		
Bearing	Sleeve bearing		
Operational torque @ ambient temperature 1.) 2.)	3 Nmm		
End stop torque 1.) 2.)	60 Ncm		
Operating temperature range	-30..+105°C		
Storage temperature range	-30..+105°C		
Protection grade (IEC 60529)	IP40		
Protection option D shaft sealing (IEC 60529)	IP65 optional		
Housing diameter	22 mm		
Housing depth	8,6 mm		
Shaft diameter	6 mm		
Shaft type	Solid shaft		

Data Sheet for Precision Potentiometer

Singleturn Wirewound Potentiometer

Series MUP

Mechanical Data, Environmental Conditions, Miscellaneous	MUP1300	MUP1350	MUP1307
Connection type	Gold plated soldering lugs		
Connection position	Radial		
Sensor mounting	Bushing		
Mass	25 g		
Fastening parts included in delivery	Nut, toothed washer		
Fastening torque mounting nut	100 Ncm		
Material shaft	Stainless steel		
Material housing	Reinforced fibreglass PBT		

1.) According IEC 60393

2.) Determined by climatic conditions according to IEC 68-1, para. 5.3.1 without load collectives

Please note: Max. permissible supply voltage <75 VDC respectively <50 VAC in addition the max. power rating must be observed

Number of wire turns / resolution							
Resistance value Ohm	100	200	500	1k	2k	5k	10k
Number of wire turns 320°	363	360	479	666	636	829	1105
Number of wire turns 270°				848		1151	1310

Ø Resolution in degree E.g. R5k = $320^\circ / 829 = 0,386^\circ$ per winding

Mounting Note: Soldering temperature max. 360°C, soldering time max. 5 s, soldering tip diameter max. 3 mm

Data Sheet for Precision Potentiometer

Singleturn Wirewound Potentiometer

Series MUP

Order code

Description		Selection: standard=black/bold, possible options=grey/cursive									
Series	MUP										
Angle of rotation with mecha. stop: 320° 270°		1300 1307 1350						W10% W10% W5%	L1% L1% L0,5%		
Resistance value / option tandem: <i>Option 100 Ohm</i> <i>Option 200 Ohm</i> <i>Option 500 Ohm</i> 1 kOhm <i>Option 2 kOhm</i> 5 kOhm 10 kOhm			<i>R100</i> <i>R200</i> <i>R500</i> R1k <i>R2k</i> R5K R10K	<i>/100</i> <i>/200</i> <i>/500</i> <i>/1k</i> <i>/2k</i> <i>/5K</i> <i>/10K</i>	<i>Tandem</i>						
<i>Option rear shaft:</i> <i>Standard Ø3,00 x 10 mm</i> <i>Shaft length in mm</i> <i>Shaft diameter in mm (≤3,00 mm)</i>						<i>RA</i> <i>RAxx,xx</i> <i>RADMx,xx</i>					
Resistance tolerance: ±10% ±5%							see above				
Independent linearity: ±1% ±0,5%								see above			
<i>Option center tap:</i>									<i>CT</i>		
Front shaft: Standard Ø6,00 x 20 mm <i>Option Shaft length in mm</i> <i>Option Shaft diameter in mm (≤6,00 mm)</i>										- <i>Ax,xx</i> <i>DMx,xx</i>	
<i>Option screwdriver slot:</i>											<i>B</i>
Shaft sealing: Standard is without sealing <i>Option D with shaft sealing</i>											- <i>D</i>

For higher quantities or on-going demand, additional options are available as described below on request

For Example: As panel encoder (with operating torque e.g. 2..3 Ncm @ room temperature), multi ganged potentiometers, sealed housing case, special electrical and mechanical angles of rotation, and special resistance and linearity tolerances. Furthermore we can mount gear wheels or attach cable assemblies with or without connectors and much more.

Data Sheet for Precision Potentiometer



Singleturn Wirewound Potentiometer

Series MUP

Drawing

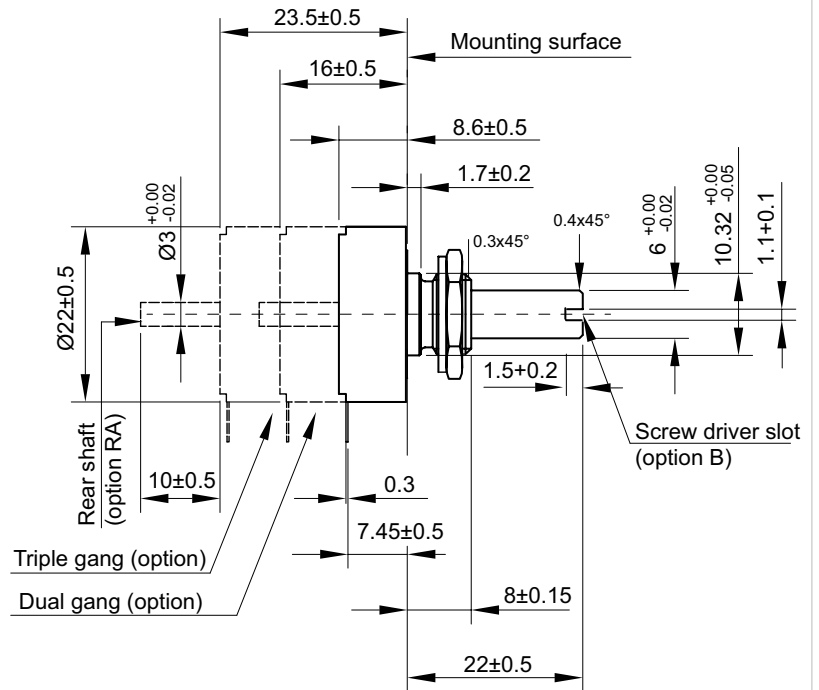
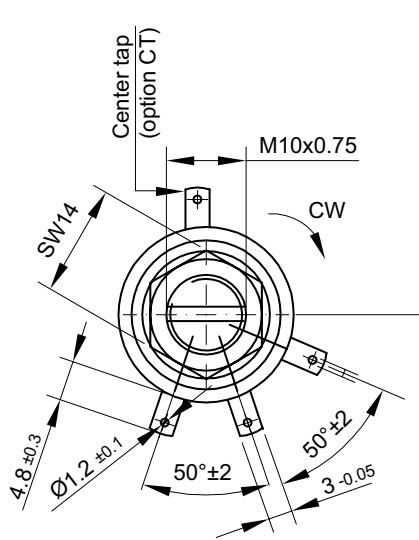

Connection diagram

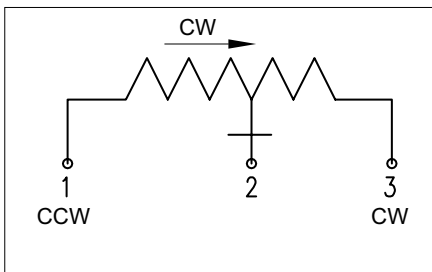

Dimension in mm

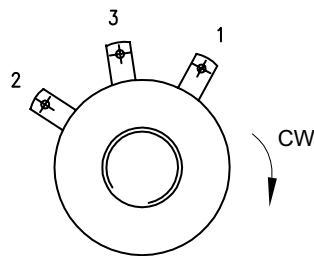

MUP1300/1350
320°

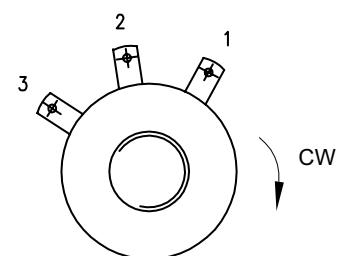

MUP1307
270°

On Request: Special machining on shaft

Slot



Groove



Flat



Round top



Double side flat

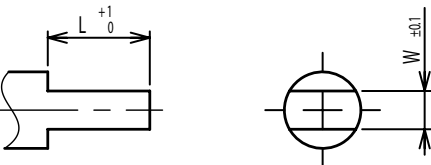

Counterbore hole

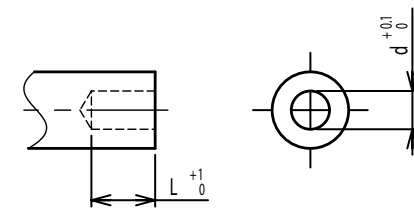

Step



Counterbore screw hole

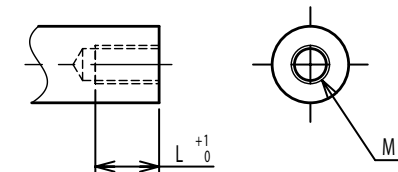

Screw Thread

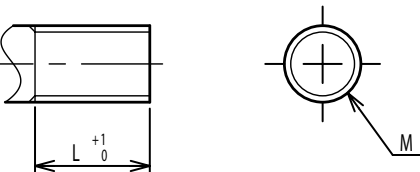

Pin hole

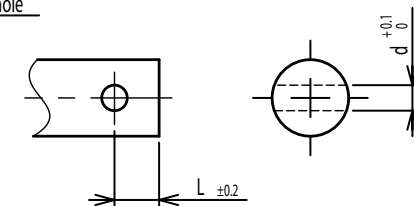

Knurled(Parallel)

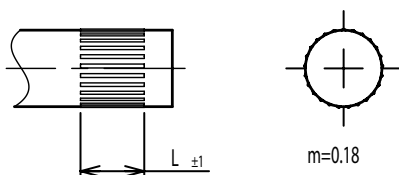

Screw thread inside hole

