

Data Sheet for Precision Potentiometer

Conductive Plastic Potentiometer

Series MFP500



Series MFP500 potentiometers in rugged industrial design

- Very long life span
- Extremely precise sensor
- 2 x ball bearings
- Servo flange for precise installation
- Robust metal housing
- Very high electrically effective angle of rotation $355^\circ \pm 2^\circ$

The MFP500 precision potentiometers are designed to meet high accuracy and reliability requirements. They have excellent linearity and life span. The housing is sealed all around and meets the requirements of IP65. For precise mounting, the potentiometer is available in two servo flange versions.

Electrical Data

Effective electrical angle of rotation 1.)	$355^\circ \pm 2^\circ$
Total resistance 1.)	1..100 kOhm
Resistance tolerance	$\pm 5\%$
Independent linearity (best straight line) 1.)	$\pm 0,1\%$ ($\pm 0,05\%$)
Theoretical resolution 1.)	Nearly infinite
Backlash (Hysteresis) 1.)	$\leq 0,5^\circ$
Max. / recommended wiper current 1.)	10 μA / 2 μA
Power rating @ 70°C (0W @ 105°C)	0,5 W
Insulation Voltage 1.)	1000 VAC, 1min
Insulation Resistance 1.)	1000 MOhm @ 1000 VDC

Mechanical Data, Environmental Conditions, Miscellaneous

Mechanical angle of rotation	360° without stop
Lifetime (90% el. eff. angle half sine) 2.)	50 Mio. rotations
Max. operational speed	400 rev. / min.
Bearing	2 x ball bearing
Operational torque @ ambient temperature 1.) 2.)	2,5 Nmm
Operating temperature range	$-55..+125^\circ\text{C}$
Storage temperature range	$-55..+125^\circ\text{C}$
Protection grade housing (IEC 60529)	IP65
Protection grade shaft (IEC 60529)	IP40
Vibration (IEC 68-2-6, Test Fc)	15g 10..2000Hz x 12h
Shock (IEC 68-2-27, Test Ea)	49g @ 11 ms x 18
Housing diameter	50,8 mm
Housing depth	40 mm
Shaft diameter	6 mm
Shaft type	Solid shaft

Data Sheet for Precision Potentiometer

Conductive Plastic Potentiometer

Series MFP500

Mechanical Data, Environmental Conditions, Miscellaneous

Max. radial load	≤1 N
Max. axial load	≤1 N
Connection type	Connector
Connection position	Axial
Sensor mounting	Servo flange (2 versions)
Mass	ca. 200 g
Fastening parts included in delivery	3 servo clamps SFN1 with screw M3 x 7,5
Material shaft	Stainless steel
Material housing	Metal

1.) According IEC 60393

2.) Determined by climatic conditions according to IEC 68-1, para. 5.3.1 without load collectives

Please note: Max. permissible supply voltage <75 VDC respectively <50 VAC in addition the max. power rating must be observed

Order code

Description	Selection: standard=black/bold, possible options=grey/cursive				
Series	MFP500				
Servo flange: Standard servo flange <i>Option Servo flange N</i>		- N			
Resistance value: 1 kOhm <i>Option 2 kOhm</i> 5 kOhm 10 kOhm <i>Option 20 kOhm</i> <i>Option 50 kOhm</i> <i>Option 100 kOhm</i>			R1k <i>R2k</i> R5k R10k <i>R20K</i> <i>R50K</i> <i>R100K</i>		
Resistance tolerance: ±5%				W5%	
Independent linearity: ±0,1% <i>Option ±0,05%</i>					L0,1% <i>L0,05%</i>
Mating connector: Standard without mating connector Mating connector ST1 angled IP40					- ST1

For higher quantities or on-going demand, additional options are available as described below on request

For Example: Special electrical and mechanical angles of rotation, and special resistance and linearity tolerances. Furthermore we can mount gear wheels or attach cable assemblies with or without connectors and much more.

Data Sheet for Precision Potentiometer



Conductive Plastic Potentiometer

Series MFP500

Drawing

MFP 500

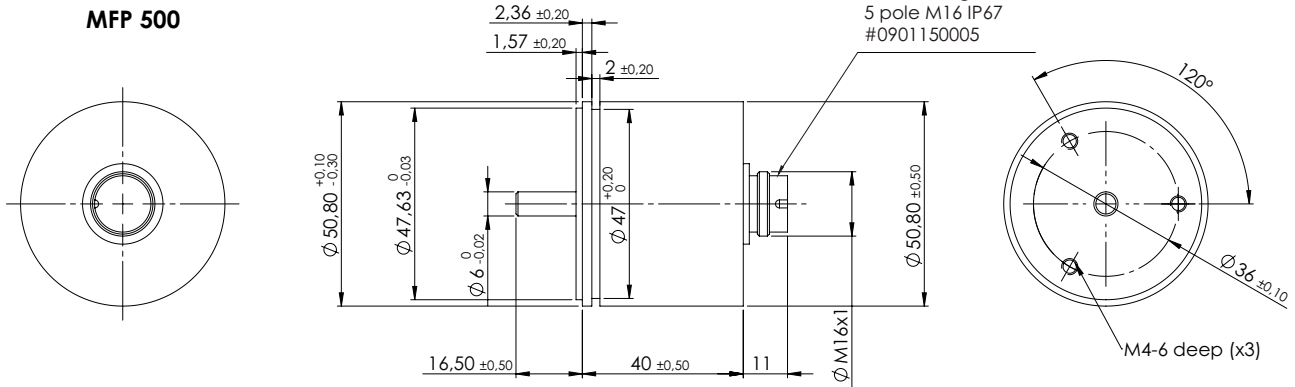

MFP 500 N

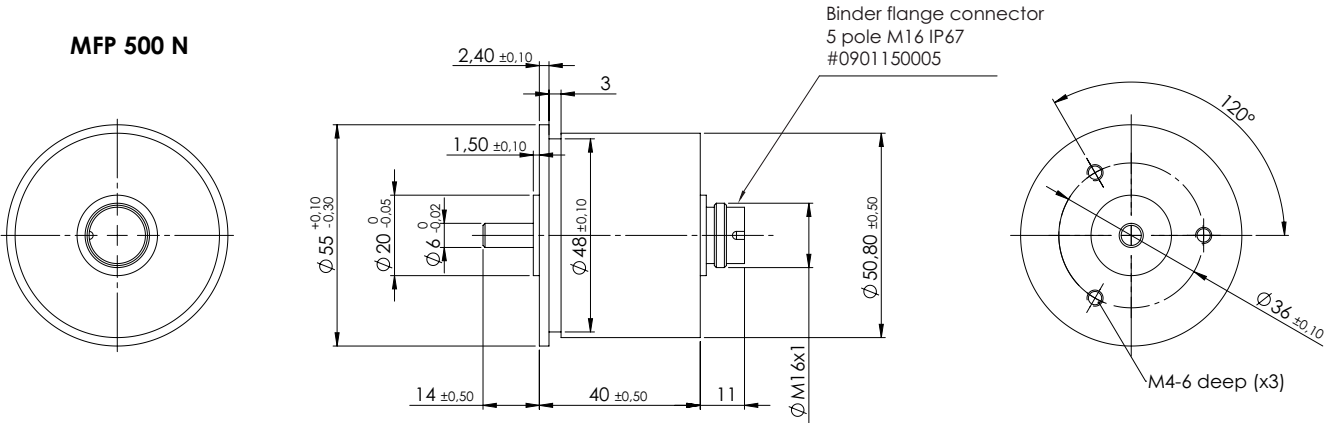

Dimensions in mm

Pitch circle MFP500

A = $\phi 57,5 \pm 0,2$
3 x M3 x 5,5

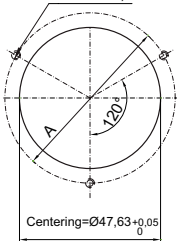

Pitch circle MFP500N

A = $\phi 61,7 \pm 0,2$
3 x M3 x 5,5

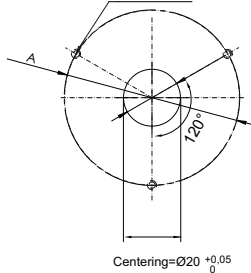

Binder female angled connector
5 pole M16 IP40 # 0901447006
MEGATRON #109835

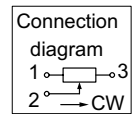
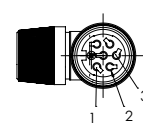
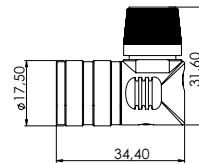

On Request: Special machining on shaft

Slot

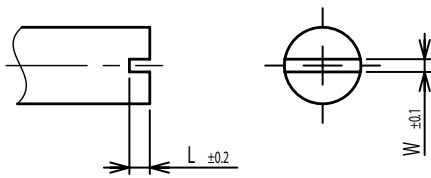

Groove

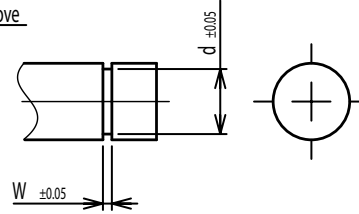

Flat

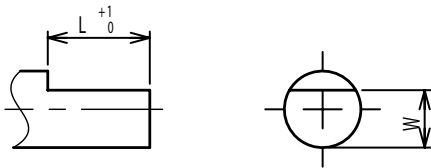

Round top

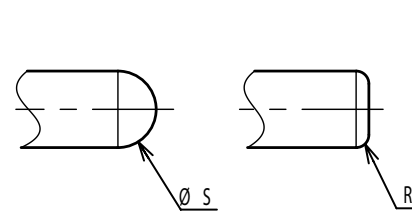

Double side flat

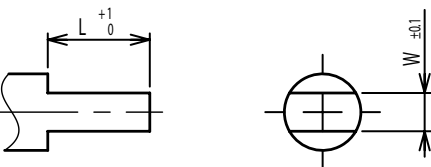

Counterbore hole

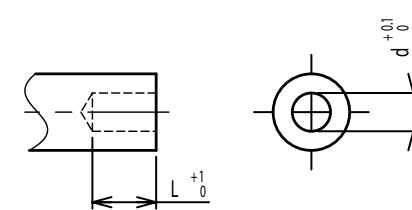

Step

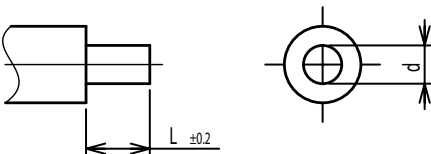

Counterbore screw hole

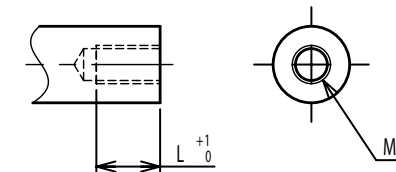

Screw Thread

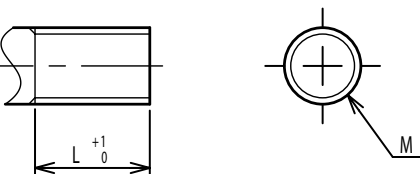

Pin hole

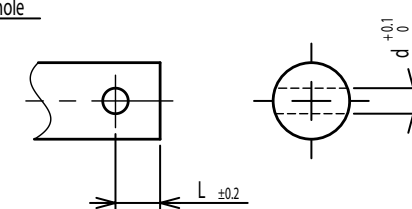

Knurled(Parallel)

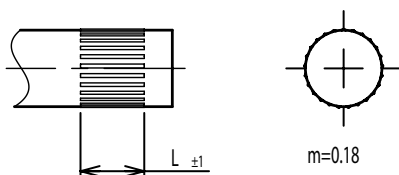

Screw thread inside hole

