

Data Sheet for Precision Potentiometer

Conductive Plastic Potentiometer

Series MCP50



The MCP50 potentiometers with precision ball bearings and servo flange are suitable for applications where a very long life with extremely high linearity, high resistance value at high load capacity and precisely mountable sensor is important.

- Very long life
- Very precise sensor
- Servo flange for precise mounting
- 2 Precision ball bearings
- Robust metal housing
- High max. resistance value
- Power saving in applications
- Very high electrically effective rotation angle $350^\circ \pm 5^\circ$

The precision potentiometers of the MCP50 series are designed for high demands on accuracy and reliability. They have outstanding linearity and excellent life expectancy. The sensor is available in a very high-resistance version for very energy-saving requirements. The potentiometer is equipped with a servo flange for precise mounting.

Electrical Data

Effective electrical angle of rotation 1.)	$350^\circ \pm 5^\circ$
Total resistance 1.)	0,5..500 kOhm
Resistance tolerance	$\pm 5\%$
Independent linearity (best straight line) 1.)	$\pm 0,1\%$ ($\pm 0,05\%$)
Theoretical resolution 1.)	Nearly infinite
Backlash (Hysteresis) 1.)	$\leq 0,5^\circ$
Max. / recommended wiper current 1.)	10 μA / 2 μA
Power rating @ 70°C (0W @ 105°C)	3 W
Insulation Voltage 1.)	1000 VAC, 1min
Insulation Resistance 1.)	1000 MOhm @ 1000 VDC

Mechanical Data, Environmental Conditions, Miscellaneous

Mechanical angle of rotation	360° without stop
Lifetime (90% el. eff. angle half sine) 2.)	50 Mio. rotations
Max. operational speed	400 rev. / min.
Bearing	2 x ball bearing
Operational torque @ ambient temperature 1.) 2.)	4 Nmm
Operating temperature range	$-55..+125^\circ\text{C}$
Storage temperature range	$-55..+125^\circ\text{C}$
Protection grade (IEC 60529)	IP40
Vibration (IEC 68-2-6, Test Fc)	15g 10..2000Hz x 12h
Shock (IEC 68-2-27, Test Ea)	49g @ 11 ms x 18
Housing diameter	51 mm
Housing depth	18 mm
Shaft diameter	6 mm
Shaft type	Solid shaft

Data Sheet for Precision Potentiometer

Conductive Plastic Potentiometer

Series MCP50

Mechanical Data, Environmental Conditions, Miscellaneous

Max. radial load	≤1 N
Max. axial load	≤1 N
Connection type	Gold plated soldering pins
Connection position	Radial
Sensor mounting	Servo flange
Mass	80 g
Fastening parts included in delivery	3 servo clamps SFN1 with screw M3 x 7,5
Material shaft	Stainless steel
Material housing	Metal

1.) According IEC 60393

2.) Determined by climatic conditions according to IEC 68-1, para. 5.3.1 without load collectives

Please note: Max. permissible supply voltage <75 VDC respectively <50 VAC in addition the max. power rating must be observed

Order code

Description	Selection: standard=black/bold, possible options=grey/cursive							
Series	MCP50							
Resistance value / Option Tandem:			<i>Tandem</i>					
<i>Option 500 Ohm</i>		<i>R500</i>	<i>/500</i>					
1 kOhm		R1k	/1K					
<i>Option 2 kOhm</i>		<i>R2k</i>	<i>/2K</i>					
5 kOhm		R5k	/5K					
10 kOhm		R10k	/10k					
<i>Option 20 kOhm</i>		<i>R20K</i>	<i>/20k</i>					
<i>Option 50 kOhm</i>		<i>R50K</i>	<i>/50k</i>					
<i>Option 100 kOhm</i>		<i>R100K</i>	<i>/100k</i>					
<i>Option 200 kOhm</i>		<i>R200k</i>	<i>/200k</i>					
<i>Option 500 kOhm</i>		<i>R500k</i>	<i>/500k</i>					
<i>Option rear shaft:</i>								
<i>Standard Ø6,00 x 15 mm</i>					RA			
<i>Shaft length in mm</i>					RAxx,xx			
<i>Shaft diameter in mm (≤6,00 mm)</i>					RADMx,xx			
Resistance tolerance: ±5%						W5%		
Independent linearity:								
±0,10%						L0,1%		
<i>Option ±0,05%</i>						L0,05%		
<i>Option center tap:</i>							CT	
Option front shaft:								
Standard Ø6,00 x 16,5 mm							-	
<i>Option Ø 6,35 x 16,5 mm</i>							DM6,35	
<i>Option shaft length in mm</i>							Ax,xx	
<i>Option shaft diameter in mm (≤6,35 mm)</i>							DMx,xx	
<i>Option screwdriver slot:</i>								B

For higher quantities or on-going demand, additional options are available as described below on request

For Example: Multi ganged potentiometers (max. 7), with mech. end stop 320° @ 90 Ncm, more center tap max. 3, special electrical and mechanical angles of rotation, and special resistance and linearity tolerances. Furthermore we can mount gear wheels or attach cable assemblies with or without connectors and much more.

Data Sheet for Precision Potentiometer

Conductive Plastic Potentiometer

Series MCP50

Drawing

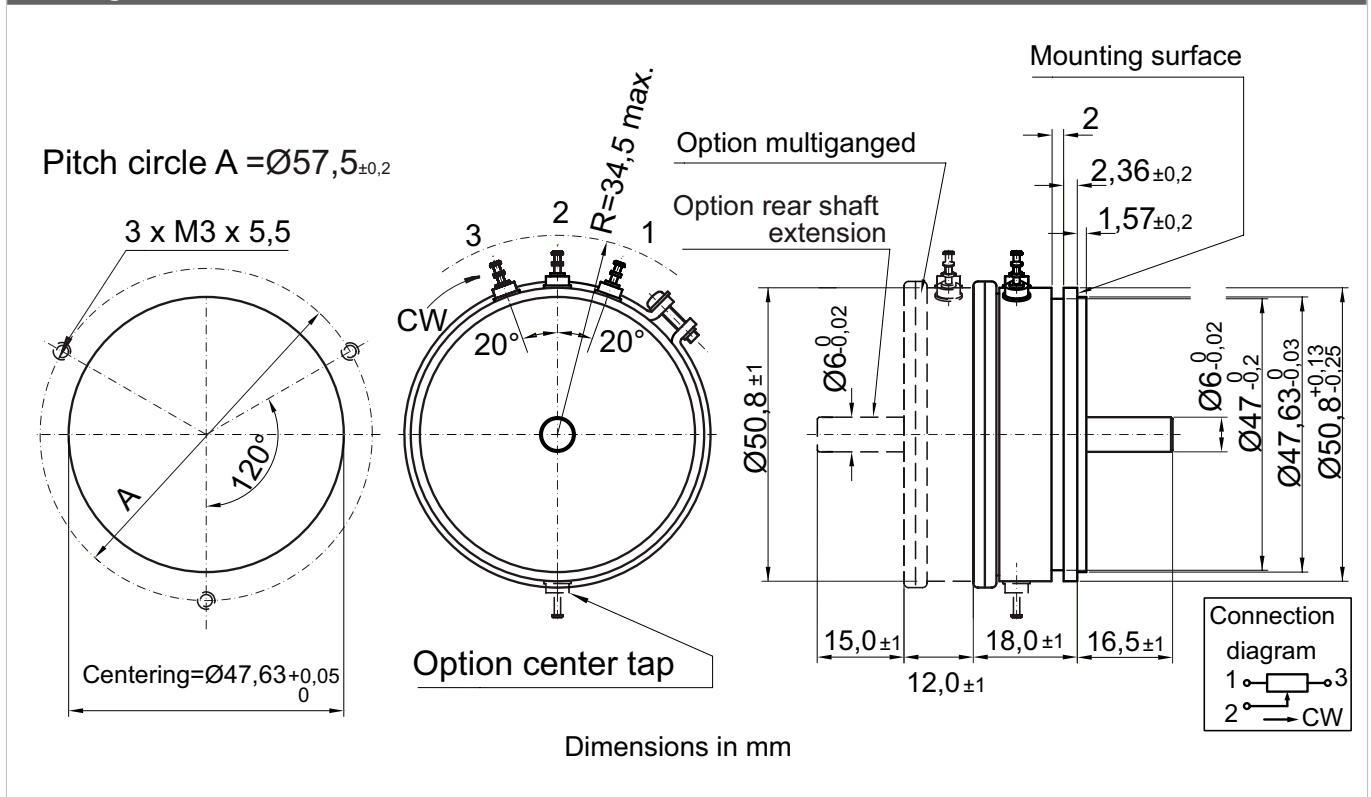

On Request: Special machining on shaft

Slot



Groove

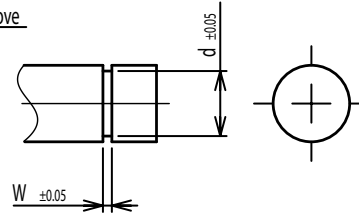

Flat



Round top

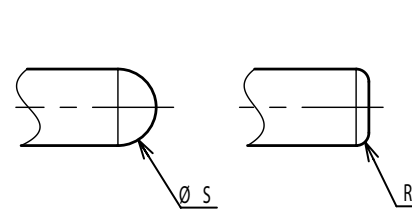

Double side flat

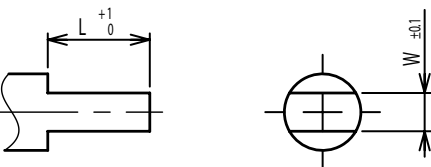

Counterbore hole

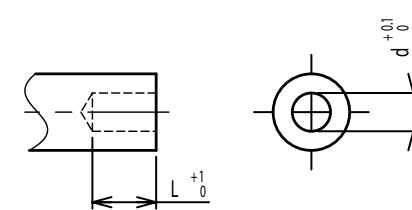

Step

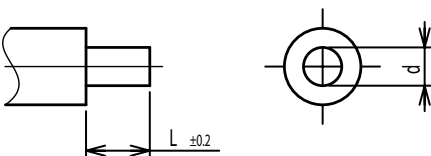

Counterbore screw hole

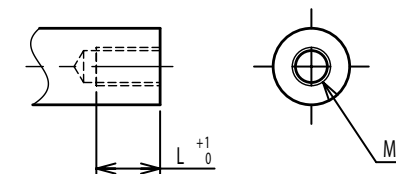

Screw Thread

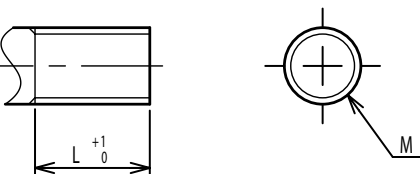

Pin hole

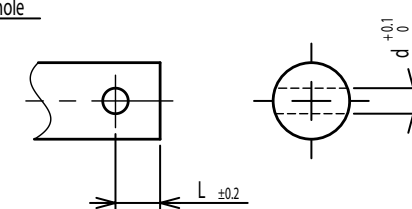

Knurled(Parallel)

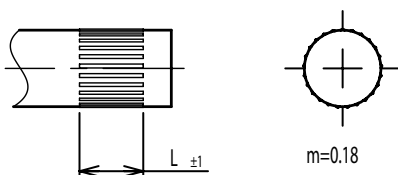

Screw thread inside hole

